

Fundamentals of Real-Time Spectrum Analysis

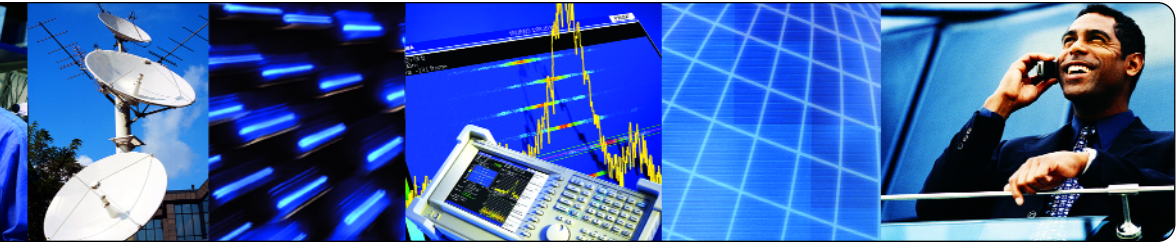

Table of Contents

Chapter 1: Introduction and Overview	2
The Evolution of RF Signals	2
Modern RF Measurement Challenges	2
A Brief Survey of Instrument Architectures	3
Swept Spectrum Analyzers:	
Traditional Frequency Domain Analysis	3
Vector Signal Analyzers: Digital Modulation Analysis	4
Real-Time Spectrum Analyzers: Trigger, Capture, Analyze	4
Key Concepts of Real-Time Spectrum Analysis	5
Samples, Frames, and Blocks	5
Real-Time Triggering	6
Seamless Capture and Spectrogram	7
Time-Correlated Multi-Domain Analysis	7
Chapter 2: How a Real-Time Spectrum Analyzer Works	10
Digital Signal Processing in Real-Time Spectrum Analyzers	10
IF Digitizer	10
Digital Down-Converter	11
I/Q Baseband Signals	11
Decimation	11
Time and Frequency Domain Effects of Sampling Rate	11
Real-Time Triggering	12
Triggering in Systems with Digital Acquisition	13
Trigger Modes and Features	13
RSA Trigger Sources	14
Constructing a Frequency Mask	15
Timing and Triggers	16
Baseband DSP	16
Calibration/Normalization	16
Filtering	16
Timing, Synchronization, and Re-sampling	16
Fast Fourier Transform Analysis	17
FFT Properties	17
Windowing	17
Post-FFT Signal Processing	18
Overlapping Frames	18
Modulation Analysis	19
Amplitude, Frequency, and Phase Modulation	19
Digital Modulation	19
Power Measurements and Statistics	20
Chapter 3: Real-Time Spectrum Analyzer Measurements	22
Frequency Domain Measurements	22
Real-Time SA	22
Standard SA	23
SA with Spectrogram	23
Time Domain Measurements	23
Frequency vs. Time	23
Power vs. Time	25
Complementary Cumulative Distribution Function	25
I/Q vs. Time	26
Modulation Domain Measurements	26
Analog Modulation Analysis	26
Digital Modulation Analysis	27
Standards-Based Modulation Analysis	28
Codogram Display	28
Chapter 4: Frequently Asked Questions	30
Chapter 5: Glossary	36
Acronym Reference	38

Chapter 1: Introduction and Overview

The Evolution of RF Signals

Engineers and scientists have been looking for innovative new uses for RF technology ever since the 1860s, when James Clerk Maxwell mathematically predicted the existence of electromagnetic waves capable of transporting energy across empty space. Following Heinrich Hertz's physical demonstration of "radio waves" in 1886, Nikola Tesla, Guglielmo Marconi, and others pioneered ways of manipulating these waves to enable long distance communications. At the turn of the century, the radio had become the first practical application of RF signals. Over the next three decades, several research projects were launched to investigate methods of transmitting and receiving signals to detect and locate objects at great distances. By the onset of World War II, radio detection and ranging (also known as radar) had become another prevalent RF application.

Due in large part to sustained growth in the military and communications sectors, technological innovation in RF accelerated steadily throughout the remainder of the 20th century and continues to do so today. To resist interference, avoid detection, and improve capacity, modern radar systems and commercial communications networks have become extremely complex, and both typically employ sophisticated combinations of RF techniques such as bursting, frequency hopping, code division multiple access, and adaptive modulation. Designing these types of advanced RF equipment and successfully integrating them into working systems are extremely complicated tasks.

At the same time, the increasingly widespread success of cellular technology and wireless data networks has caused the cost of basic RF components to plummet. This has enabled manufacturers outside of the traditional military and communications realms to embed relatively simple RF devices into all sorts of commodity products. RF transmitters have become so pervasive that they can be found in almost any imaginable location: consumer electronics in homes, medical devices in hospitals, industrial control systems in factories, and even tracking devices implanted underneath the skin of livestock, pets, and people.

As RF signals have become ubiquitous in the modern world, so too have problems with interference between the devices that generate them. Products such as mobile phones that operate in license

spectrum must be designed not to transmit RF energy into adjacent frequency channels, which is especially challenging for complex multi-standard devices that switch between different modes of transmission and maintain simultaneous links to different network elements. Simpler devices that operate in unlicensed frequency bands must also be designed to function properly in the presence of interfering signals, and government regulations often dictate that these devices are only allowed to transmit in short bursts at low power levels.

In order to overcome these evolving challenges, it is crucial for today's engineers and scientists to be able to reliably detect and characterize RF signals that change over time, something not easily done with traditional measurement tools. To address these problems, Tektronix has designed the Real-Time Spectrum Analyzer (RTSA), an instrument that can trigger on RF signals, seamlessly capture them into memory, and analyze them in the frequency, time, and modulation domains. This document has been written to describe how the RTSA works and provide a basic understanding of how it can be used to solve many measurement problems associated with capturing and analyzing modern RF signals.

Modern RF Measurement Challenges

Given the challenge of characterizing the behavior of today's RF devices, it is necessary to understand how frequency, amplitude, and modulation parameters behave over short and long periods of time. In these cases, using traditional tools like swept spectrum analyzers (SA) and vector signal analyzers (VSA) might provide snapshots of the signal in the frequency domain and the modulation domain, but this is often not enough information to confidently describe the dynamic RF signals produced by the device. The RTSA adds another crucial dimension to all of these measurements – time.

Consider the following common measurement tasks:

- Transient and dynamic signal capture and analysis
- Capturing burst transmissions, glitches, switching transients
- Characterizing PLL settling times, frequency drift, microphonics
- Detecting intermittent interference, noise analysis
- Capturing spread-spectrum and frequency-hopping signals
- Monitoring spectrum usage, detecting rogue transmissions
- Compliance testing, EMI diagnostics

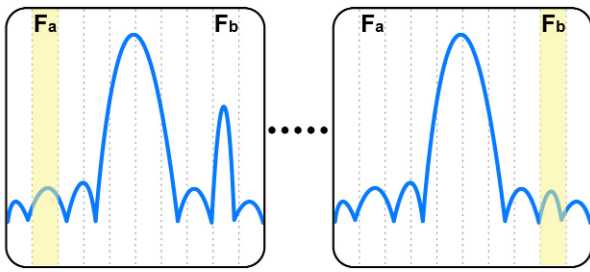

Figure 1-1: The swept spectrum analyzer steps across a series of frequency segments, often missing important transient events that occur outside the current sweep band highlighted in yellow.

- Analog and digital modulation analysis
- Characterizing time-variant modulation schemes
- Troubleshooting complex wireless standards using domain correlation
- Performing modulation quality diagnostics

Each measurement involves RF signals that change over time, often unpredictably. To effectively characterize these signals, engineers need a tool that can trigger on known or unpredictable events, capture the signals seamlessly and store them in memory, and analyze the behavior of frequency, amplitude, and modulation parameters over time.

A Brief Survey of Instrument Architectures

The Real-Time Spectrum Analyzer (RTSA) is an innovative measurement tool designed by Tektronix to address the emerging RF measurement challenges described above. To learn how the RTSA works and understand the value of the measurements it provides, it is helpful to first examine two other types of traditional RF signal analyzers: the swept spectrum analyzer (SA) and the vector signal analyzer (VSA).

The Swept Spectrum Analyzer: Traditional Frequency Domain Analysis

The swept-tuned, superheterodyne spectrum analyzer is the traditional architecture that first enabled engineers to make frequency domain measurements several decades ago. Originally built with purely analog components, the swept SA has since evolved along with the applications that it serves. Current generation swept SAs includes digital elements such as ADCs, DSPs, and microproces-

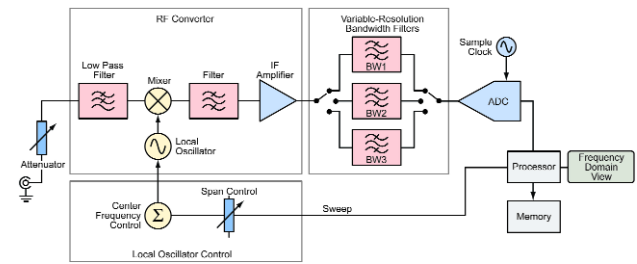

Figure 1-2: Typical swept spectrum analyzer architecture.

sors. However, the basic swept approach remains largely the same and is best suited for observing controlled, static signals.

The swept SA makes power vs. frequency measurements by downconverting the signal of interest and sweeping it through the passband of a resolution bandwidth (RBW) filter. The RBW filter is followed by a detector that calculates the amplitude at each frequency point in the selected span. While this method can provide high dynamic range, its disadvantage is that it can only calculate the amplitude data for one frequency point at a time. Sweeping the analyzer over a span of frequencies takes time – on the order of seconds in some cases. This approach is based on the assumption that the analyzer can complete several sweeps without there being significant changes to the signal being measured. Consequently, a relatively stable, unchanging input signal is required.

If there is a rapid change in the signal, it is statistically probable that the change will be missed. As shown in Figure 1-1, the sweep is looking at frequency segment F_a while a momentary spectral event occurs at F_b (diagram on left). By the time the sweep arrives at segment F_b , the event has vanished and does not get detected (diagram on right). The SA does not provide a way to trigger on this transient signal, nor can it store a comprehensive record of signal behavior over time.

Figure 1-2 depicts a typical modern swept SA architecture. It supplements the wide analog resolution bandwidth (RBW) filters inherited from its predecessors with digital techniques to replace the narrower filters. Filtering, mixing, and amplification prior to the ADC are analog processes for bandwidths in the range of BW_1 , BW_2 , or BW_3 . When filters narrower than “ BW_3 ” are needed, they are applied by digital signal processing (DSP) in the steps following the analog-to-digital conversion.

Fundamentals of Real-Time Spectrum Analysis

► Primer

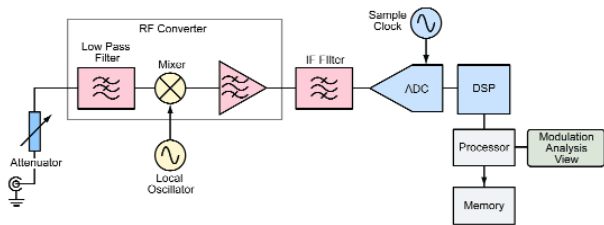

Figure 1-3: Typical vector signal analyzer architecture.

The job of the ADC and the DSP is rather demanding. Non-linearity and noise in the ADC are a challenge, although some types of errors that can occur in purely analog spectrum analyzers are eliminated.

Vector Signal Analyzers: Digital Modulation Analysis

Traditional swept spectrum analysis enables scalar measurements that provide information only about the magnitude of the input signal. Analyzing signals carrying digital modulation requires vector measurements that provide both magnitude and phase information. The vector signal analyzer is a tool specifically designed for digital modulation analysis. A simplified VSA block diagram is shown in Figure 1-3.

The VSA is optimized for modulation measurements. Like the Real-Time Spectrum Analyzer described in the next section, a VSA digitizes all of the RF energy within the passband of the instrument in order to extract the magnitude and phase information required to measure digital modulation. However, most (but not all) VSAs are designed to take snapshots of the input signal at arbitrary points in time, which makes it difficult or impossible to store a long record of successive acquisitions for a cumulative history of how a signal behaves over time. Like a swept SA, the triggering capabilities are typically limited to an IF level trigger and an external trigger.

Within the VSA, an ADC digitizes the wideband IF signal, and the down-conversion, filtering, and detection are performed numerically. Transformation from time domain to frequency domain is done using FFT algorithms. The linearity and dynamic range of the ADC are critical to the instrument's performance. Equally important, there must be sufficient DSP processing power to enable fast measurements.

The VSA measures modulation parameters such as Error Vector Magnitude (EVM) and provides other displays such as the

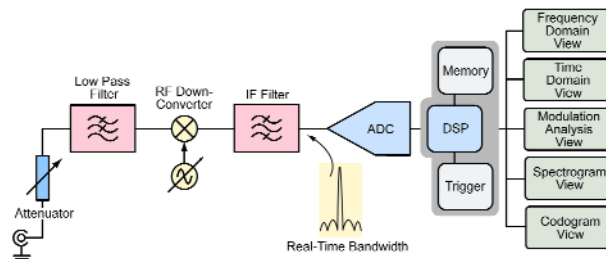

Figure 1-4: Typical real-time spectrum analyzer architecture.

constellation diagram. A standalone VSA is often used to supplement the capabilities of a traditional swept SA. In addition, many modern instruments have architectures that can perform both swept SA and VSA functions, providing non-correlated frequency and modulation domain measurements in one box.

Real-Time Spectrum Analyzers: Trigger, Capture, Analyze

The Real-Time Spectrum Analyzer is designed to address the measurement challenges associated with transient and dynamic RF signals as described in the previous section. The fundamental concept of real-time spectrum analysis is the ability to trigger on an RF signal, seamlessly capture it into memory, and analyze it in multiple domains. This makes it possible to reliably detect and characterize RF signals that change over time.

Figure 1-4 shows a simplified block diagram of the RTSA architecture. (A more detailed diagram and circuit description appears in Chapter 2). The RF front-end can be tuned across the entire frequency range of the instrument, and it down-converts the input signal to a fixed IF that is related to the maximum real-time bandwidth of the RTSA. The signal is then filtered, digitized by the ADC, and passed to the DSP engine that manages the instrument's triggering, memory, and analysis functions. While elements of this block diagram and acquisition process are similar to those of the VSA architecture, the RTSA is optimized to deliver real-time triggering, seamless signal capture, and time-correlated multi-domain analysis. In addition, advancements in ADC technology enable a conversion with high dynamic range and low noise, allowing the RTSA to equal or surpass the basic RF performance of many swept spectrum analyzers.

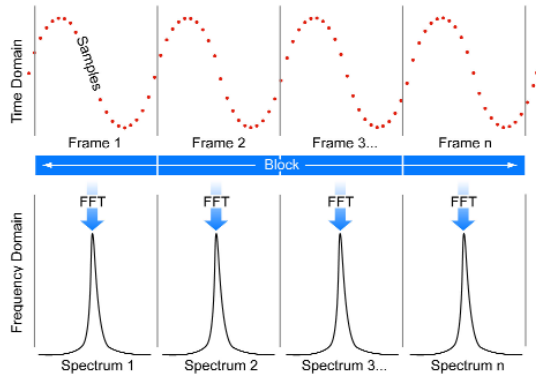

Figure 1-5: Samples, frames, and blocks: the memory hierarchy of the RSA.

For measurement spans less than or equal to the real-time bandwidth, the RTSA architecture provides the ability to seamlessly capture the input signal with no gaps in time by digitizing the RF signal and storing the time-contiguous samples in memory. This has several advantages over the acquisition process of a swept spectrum analyzer, which builds up a frequency domain image by serially sweeping across the frequency span. The remainder of this document discusses these advantages in detail.

Key Concepts of Real-Time Spectrum Analysis

Samples, Frames, and Blocks

The measurements performed by the RTSA are implemented using digital signal processing (DSP) techniques. To understand how an RF signal can be analyzed in the time, frequency, and modulation domains, it is first necessary to examine how the instrument acquires and stores the signal. After it is digitized by the ADC, the signal is represented by time domain data, from which all frequency and modulation parameters can be calculated using DSP. These concepts are discussed in detail in Chapter 2.

Three terms—samples, frames, and blocks—describe the hierarchy of data stored when an RTSA seamlessly captures a signal using real-time acquisition. Figure 1-5 illustrates the sample-frame-block structure.

The lowest level of the hierarchy of data is the **sample**, which represents a discrete time-domain data point. This construct is familiar from other applications

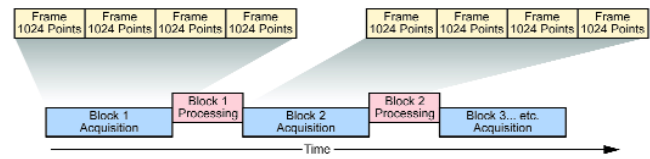

Figure 1-6: Real-time spectrum analyzer block acquisition and processing.

of digital sampling, such as a real-time oscilloscopes and PC-based digitizers. The effective sample rate which determines the time interval between adjacent samples depends on the selected span. In the RTSA, each sample is stored in memory as an I/Q pair containing magnitude and phase information.

The next step up is the **frame**. A frame consists of an integer number of contiguous samples and is the basic unit to which the Fast Fourier Transform (FFT) can be applied to convert time domain data into the frequency domain. In this process, each frame yields one frequency domain spectrum.

The highest level in the acquisition hierarchy is the **block**, which is made up of many adjacent frames that are captured seamlessly in time. The block length (also referred to as acquisition length) is the total amount of time that is represented by one continuous acquisition. Within a block, the input signal is represented with no gaps in time.

In the real-time measurement modes of the RTSA, each block is seamlessly acquired and stored into memory. It is then post-processed using DSP techniques to analyze the frequency, time, and modulation behavior of the signal. In standard SA modes, the RTSA can emulate a swept SA by stepping the RF front end across frequency spans that exceed the maximum real-time bandwidth. Additional information can be found in Chapter 4.

Figure 1-6 shows block acquisition mode, which enables real-time seamless capture. Each acquisition is seamless in time for all the frames within a block, though not between blocks. After the signal

Fundamentals of Real-Time Spectrum Analysis

► Primer

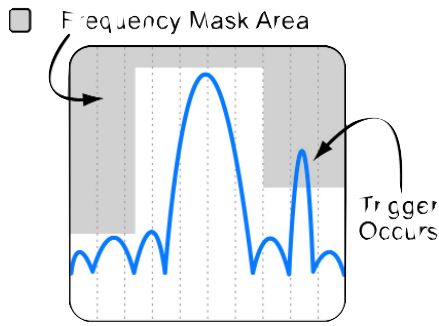

Figure 1-7: Real-time frequency domain triggering using a frequency mask.

processing of one acquisition block is complete, the acquisition of the next block will begin. Once the block is stored in memory any real-time measurements can be applied. For example, a signal captured in real-time SA mode can then be analyzed in demod mode and time mode.

The number of frames acquired within the block can be determined by dividing the acquisition length by the frame length. The acquisition length entered by the user is rounded so the block contains an integer number of frames. The maximum acquisition length ranges from seconds to days and depends on the selected measurement span and the memory depth of the instrument. Examples for specific RTSAs are given in Chapter 4.

Real-Time Triggering

Useful triggering has long been a missing ingredient in most spectrum analysis tools. The RTSA is the first mainstream spectrum analyzer to offer real-time frequency domain triggering and other intuitive trigger modes in addition to simple IF level and external triggers. There are many reasons that the traditional swept architecture is not well suited for real-time triggering, most significantly that in a swept SA a trigger event is used to begin a sweep. The RTSA, on the other hand, uses a trigger event as a reference point in time for the seamless acquisition of the signal. This enables several other useful features, such as the ability to store both pre-trigger and post-trigger information. An in-depth discussion of the real-time triggers of the RTSA can be found in Chapter 2.

Another significant capability of the RTSA is the real-time frequency mask trigger, which allows the user to trigger an acquisition based

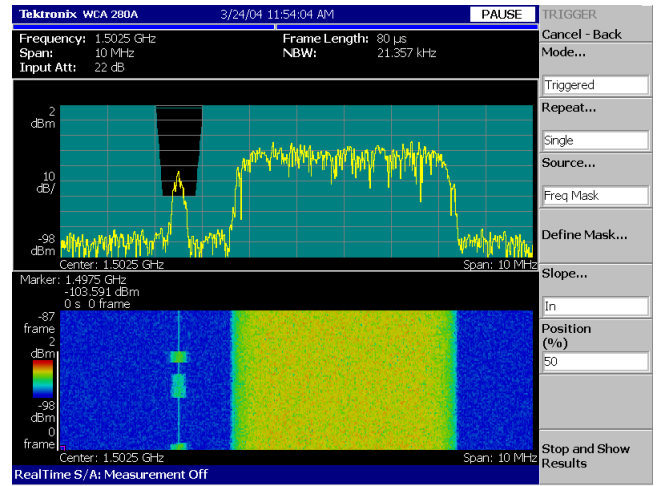

Figure 1-8: Using the frequency mask to trigger on a low level burst in the presence of a large signal.

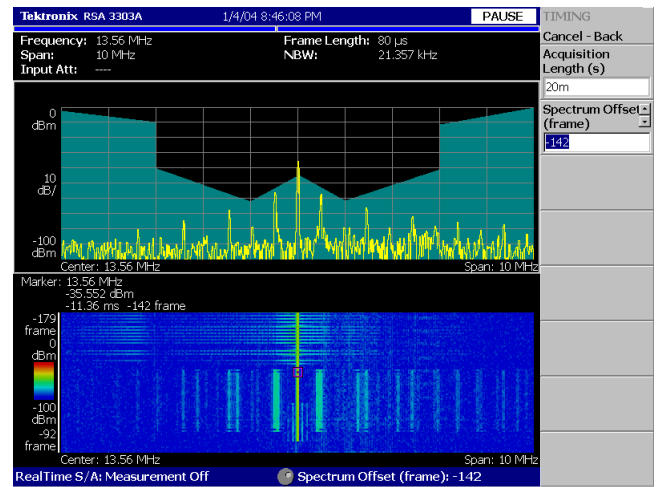

Figure 1-9: Using the frequency mask to trigger on a specific signal in a crowded spectral environment.

on specific events in the frequency domain. As illustrated in Figure 1-7, a mask is drawn to define the set of conditions within the analyzer's real-time bandwidth will generate the trigger event.

The flexible frequency mask trigger is a powerful tool for reliably detecting and analyzing dynamic RF signals. It can be also used to make measurements that are impossible with traditional spectrum analyzers, such as capturing low-level transient events that occur in the presence of more powerful RF signals (as shown in Figure 1-8) and detecting intermittent signals at specific frequencies within a crowded frequency spectrum (as shown in Figure 1-9).

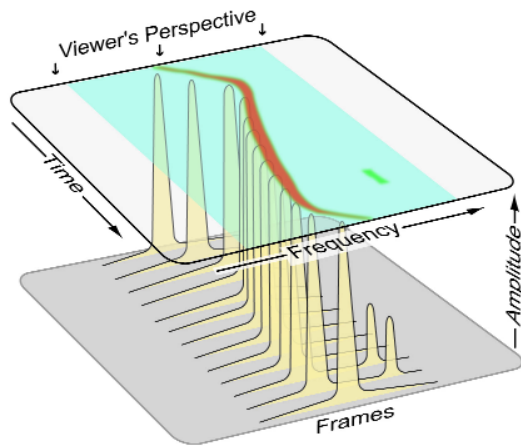

Figure 1-10: Spectrogram display.

Seamless Capture and Spectrogram

Once the real-time trigger conditions have been defined and the instrument is armed to begin an acquisition, the RTSA continuously examines the input signal to watch for the specified trigger event. While waiting for this event to occur, the signal is constantly digitized and the time domain data is cycled through a first-in, first-out capture buffer that discards the oldest data as new data is accumulated. This enables the analyzer to save pre-trigger and post-trigger data into memory when it detects the trigger event.

As described in the sections above, this process enables a seamless acquisition of the specified block, within which a signal is represented by contiguous time domain samples. Once this data has been stored in memory, it is available to process and analyze using different displays such as power vs. frequency, spectrogram, and multi-domain views. The sample data remains available in random access memory until it is overwritten by a subsequent acquisition, and it can also be saved to the internal hard drive of the RTSA.

The spectrogram is an important measurement that provides an intuitive display of how frequency and amplitude behavior change over time. The horizontal axis represents the same range of frequencies that a traditional spectrum analyzer shows on the power vs. frequency display. In the spectrogram, though the vertical axis represents time, and amplitude is represented by the color of the trace. Each “slice” of the spectrogram corresponds to a single frequency spectrum calculated from one frame of time domain data. Figure 1-10 shows a conceptual illustration of the spectrogram of a dynamic signal.

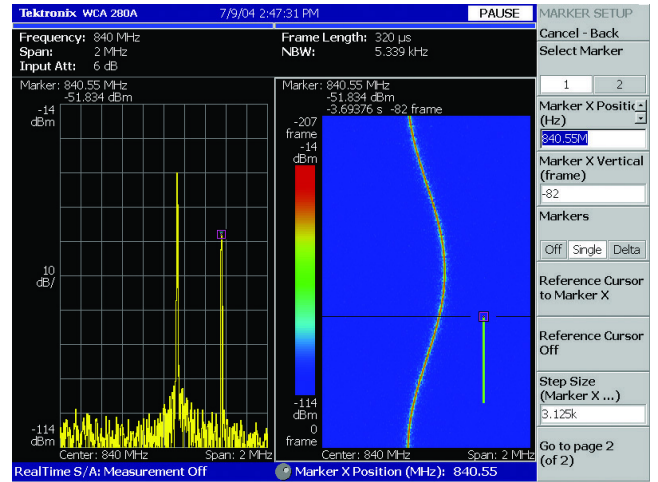

Figure 1-11: Time-correlated views: power vs. frequency display (left) and spectrogram display (right).

Figure 1-11 shows a screen shot displaying the power vs. frequency and spectrogram displays for the signal illustrated in Figure 1-10. On the spectrogram, the oldest frame is shown at the top of the display and the most recent frame is shown at the bottom of the display. This measurement shows an RF signal whose frequency is changing over time, and it also reveals a low level transient signal that appears and disappears near the end of the time block. Since the data is stored in memory, a marker can be used to scroll “back in time” through the spectrogram. In Figure 1-11, a marker has been placed on the transient event on the spectrogram display, which causes the spectrum corresponding to that particular point in time to be shown on the power vs. frequency display.

Time-Related Multi-Domain Analysis

Once a signal has been acquired and stored in memory, it can be analyzed using the wide variety of time-correlated views available in the RTSA, as illustrated in Figure 1-12 (next page).

This is especially useful for device troubleshooting and signal characterization applications. All of these measurements are based on the same underlying set of time domain sample data, which underscores two significant architectural advantages:

- Comprehensive signal analysis in the frequency, time, and modulation domains based on a single acquisition.
- Domain correlation to understand how specific events in the frequency, time, and modulation domains are related based on a common time reference.

Fundamentals of Real-Time Spectrum Analysis

► Primer

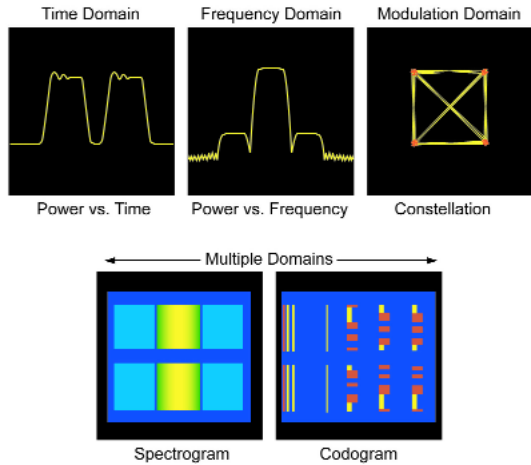

Figure 1-12: Illustrations of several time-correlated measurements available on RTSA's.

In real-time spectrum analysis mode, the RTSA provides two time-correlated views of the captured signal: the power vs. frequency display and the spectrogram display. These two views can be seen in Figure 1-11.

In the other real-time measurement modes for time domain analysis and modulation domain analysis, the RTSA shows multiple views of the captured signal as illustrated in Figures 1-13 and 1-14. The window in the upper left is called the overview, and it can display either power vs. time or the spectrogram. The overview shows all of the data that was acquired in the block, and it serves as the index for the other analysis windows.

The window in the upper right (outlined in purple) is called the subview, and it shows the same power vs. frequency display that is available in Real-Time Spectrum Analyzer mode. Just like the display in Figure 1-11, this is the spectrum of one frame of data, and it is possible to scroll through the entire time record to see the spectrum at any point in time. This is done by adjusting the spectrum offset, which is found in the Timing menu of the RTSA. Also note that there is a purple bar in the overview window that indicates position in time that corresponds to the frequency domain display in the purple subview window.

The window in the bottom half of the screen (outlined in green) is called the analysis window, or mainview, and it displays the results of the selected time or modulation analysis measurement.

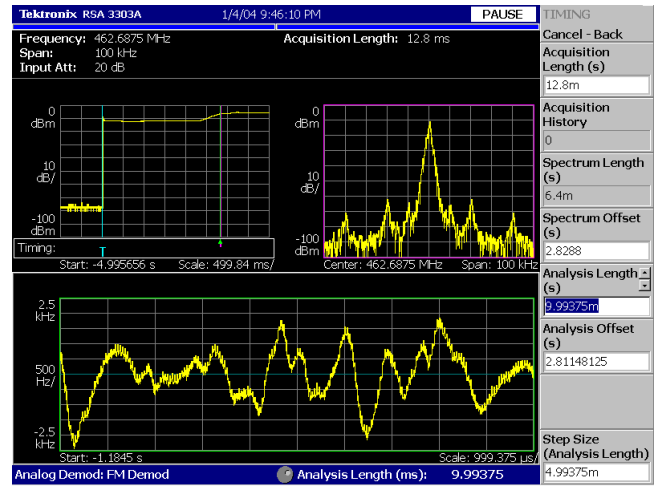

Figure 1-13: Multi-domain view showing power vs. time, power vs. frequency, and FM demodulation.

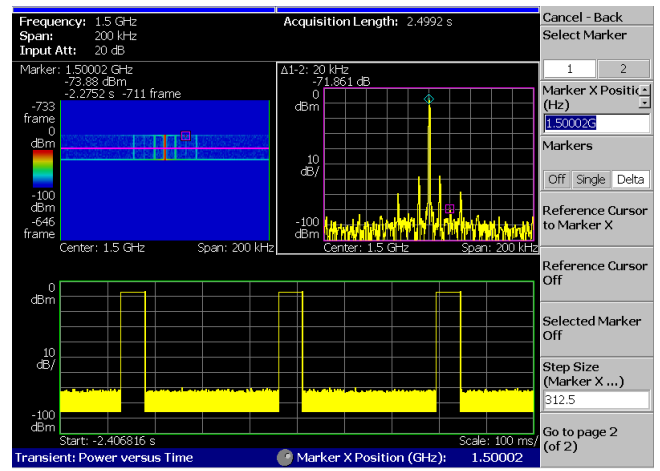

Figure 1-14: Multi-domain view showing spectrogram, power vs. frequency, and power vs. time.

Figure 1-13 shows an example of frequency modulation analysis, and Figure 1-14 shows an example of transient power vs. time analysis. Like the subview window, the green analysis window can be positioned anywhere within the time record shown in the overview window, which has corresponding green bars to indicate its position. In addition, the width of the analysis window can be flexibly adjusted to lengths less than or greater than one frame.

Time-correlated multi-domain analysis provides tremendous flexibility to zoom in and thoroughly characterize different parts of an acquired RF signal using a wide variety of analysis tools. An introduction to these measurements can be found in Chapter 3.

Fundamentals of Real-Time Spectrum Analysis

► Primer

Chapter 2: How a Real-Time Spectrum Analyzer Works

Modern Real-Time Spectrum Analyzers can acquire a passband, or span, anywhere within the input frequency range of the analyzer. At the heart of this capability is an RF down-converter followed by a wideband intermediate frequency (IF) section. An ADC digitizes the IF signal and the system carries out all further steps digitally. An FFT algorithm implements the transformation from time domain to frequency domain, where subsequent analysis produces displays such as spectrograms, codograms, and more.

Several key characteristics distinguish a successful real-time architecture:

- An ADC system capable of digitizing the entire real-time BW with sufficient fidelity to support the desired measurements.
- An integrated signal analysis system that provides multiple analysis views of the signal under test, all correlated in time.
- Sufficient capture memory and DSP power to enable continuous real-time acquisition over the desired time measurement period.
- DSP power to enable real-time triggering in the frequency domain.

This chapter contains several architectural diagrams of the main acquisition and analysis blocks of the Tektronix Real-Time Spectrum Analyzer (RSA). Some ancillary functions (minor triggering-related blocks, display and keyboard controllers, etc.) have been omitted to clarify the discussion.

Digital Signal Processing in Real-Time Spectrum Analyzers

Tektronix' RSAs use a combination of analog and digital signal processing to convert RF signals into calibrated, time-correlated multi-domain measurements. This section deals with the digital portion of the RSA signal processing flow.

Figure 2-1 illustrates the major digital signal processing blocks used in the Tektronix RSA Series. An analog IF signal is bandpass filtered and digitized. A digital down-conversion and decimation process converts the A/D samples into streams of in-phase (I) and quadrature (Q) base band signals. A triggering block detects signal conditions to control acquisition and timing. The baseband I and Q signals as well as triggering information are used by a baseband DSP system to perform spectrum analysis by means of FFT, modulation analysis, power measurements, timing measurements as well as statistical analyses.

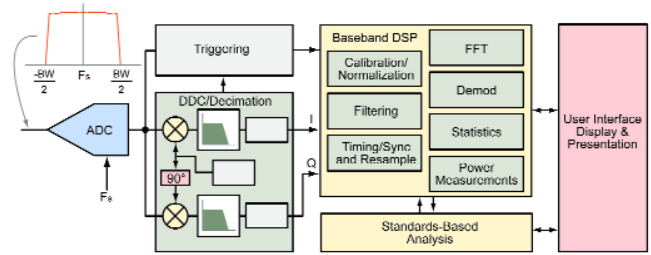

Figure 2-1: Real-time spectrum analyzer digital signal processing block diagram.

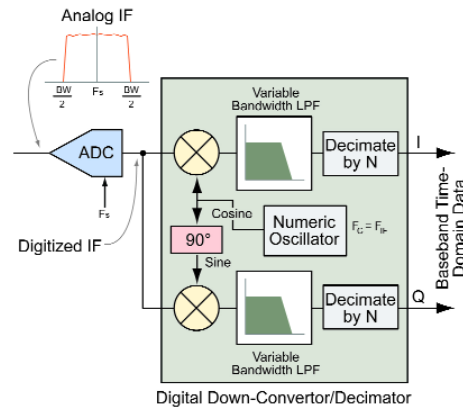

Figure 2-2: Digital down-converter block diagram.

IF Digitizer

Tektronix RSAs typically digitize a band of frequencies centered around an intermediate frequency (IF). This band or span of frequencies is the widest frequency for which real-time analysis can be performed. Digitizing at a high IF rather than at DC or baseband has several signal processing advantages (spurious performance, DC rejection, dynamic range, etc.) but can require excessive computation to filter and analyze if processed directly. Tektronix RSAs employ a digital down-converter (DDC), Figure 2-2 and a decimator to convert a digitized IF into I and Q baseband signals at an effective sampling rate just high enough for the selected span.

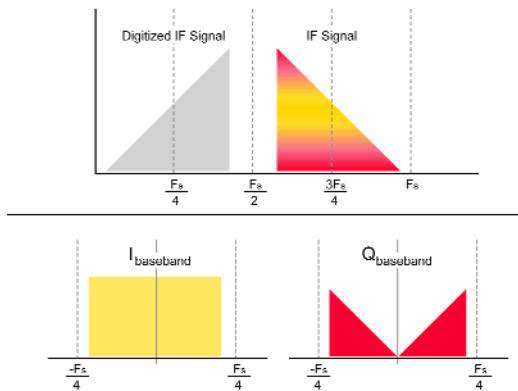

Figure 2-3: Information in the passband is maintained in I and Q, even at half the sample rate.

Digital Down Converter

The IF signal is digitized with sample rate F_s . The digitized IF is then sent to a DDC. A numeric oscillator in the DDC generates a sine and a cosine at the center frequency of the band of interest. The sine and cosine are numerically multiplied with the digitized IF, generating streams of I and Q baseband samples that contain all of the information present in the original IF. The I and Q streams then pass through variable bandwidth low-pass filters. The cutoff frequency of the low-pass filters is varied according to the selected span.

I and Q Baseband Signals

Figure 2-3 illustrates the process of taking a frequency band and converting it to baseband using quadrature down-conversion. The original IF signal is contained in the space between three halves of the sampling frequency and the sampling frequency. Sampling produces an image of this signal between zero and one-half the sampling frequency. The signal is then multiplied with coherent sine and cosine signals at the center of the passband of interest, generating I and Q baseband signals. The baseband signals are real-valued and symmetric about the origin. The same information is contained in the positive and negative frequencies. All of the modulation contained in the original passband is also contained in these two signals. The minimum required sampling frequency for each is now half of the original. It is then possible to decimate by two.

Span	Decimation (n)	Effective Sample Rate	Time Resolution
15 MHz	2	25.6 MS/s	39.0625 ns
10 MHz	4	12.8 MS/s	78.1250 ns
1 MHz	40	1.28 MS/s	781.250 ns
100 KHz	400	128 KS/s	7.81250 s
10 KHz	4000	12.8 KS/s	78.1250 s
1 KHz	40000	1.28 KS/s	781.250 s
100 Hz	400000	128 S/s	7.81250 ms

Table 2-1: Selected span, decimation and effective sample rates. (Tektronix RSA3300A Series and WCA200A Series)

Decimation

The Nyquist theorem states that for baseband signals one need only sample at a rate equal to twice the highest frequency of interest. Time and frequency are reciprocal quantities. To study low frequencies it is necessary to observe a long record of time. Decimation is used to balance span, processing time, record length and memory usage.

The Tektronix RSA3300A Series, for example, uses a 51.2 MS/s sampling rate at the A/D converter to digitize a 15 MHz bandwidth, or span. The I and Q records that result after DDC, filtering and decimation for this 15 MHz span are at an effective sampling rate of half the original, that is, 25.6 MS/s. The total number of samples is unchanged: we are left with two sets of samples, each at an effective rate of 25.6 MS/s instead of a single set at 51.2 MS/s. Further decimation is made for narrower spans, resulting in longer time records for an equivalent number of samples. The disadvantage of the lower effective sampling rate is a reduced time resolution. The advantages of the lower effective sampling rate are fewer computations and less memory usage for a given time record, as shown in Table 2-1.

Time and Frequency Domain Effects of Sampling Rate

Using decimation to reduce the effective sampling rate has several consequences for important time and frequency domain measurement parameters. An example contrasting a wide span and a narrow span is shown in Figures 2-4 and 2-5. A more thorough discussion and additional examples can be found in the FAQ in Chapter 4.

Fundamentals of Real-Time Spectrum Analysis

► Primer

Instrument Settings	Wide span	Narrow span
Span	15 MHz	1 kHz
Sample Rate	51.2 MS / second	51.2 MS / second
Decimation	2	32000
Effective Sample Rate	25.6 MS / second	1.6 kS / second
Time Domain Effects		
Time Domain Resolution (sample)	39.0 nanoseconds	625 microseconds
Spectrogram Time Resolution (frame length)	40.0 microseconds	640 milliseconds
Maximum Record Length (256 MB memory)	2.56 seconds	11.4 hours
Frequency Domain Effects		
Frequency Resolution (FFT bin width)	25.0 kHz	1.56 Hz
NBW (noise bandwidth)	43.7 kHz	2.67 Hz
Equivalent Gaussian RBW	41.2 kHz	2.52 Hz

Table 2-2: Comparison of time and frequency domain effects of changing the span setting. (Tektronix RSA3300A Series and WCA200A Series)

A wide capture bandwidth displays a broad span of frequencies with relatively low frequency domain resolution. Compared to narrower capture bandwidths, the sample rate is higher, and the resolution bandwidth is wider. In the time domain, frame length is shorter, and time resolution is finer. Record length is the same in terms of the number of stored samples, but the amount of time represented by these samples is shorter. Figure 2-4 illustrates a wide bandwidth capture, and Table 2-2 provides a real-world example.

In contrast, a narrow capture bandwidth displays a small span of frequencies with higher frequency domain resolution. Compared to wide capture bandwidths, the sample rate is lower, while the resolution bandwidth is narrower. In the time domain, the frame length is longer, time resolution is coarser, and the available record length encompasses more time. Figure 2-5 illustrates a narrow bandwidth capture, and Table 2-2 provides a real-world example. Note the scale of the numbers such as frequency resolution — they are several orders of magnitude different from the wideband capture.

Real-Time Triggering

The Real-Time Spectrum Analyzer adds the power of the time domain to spectrum and modulation analysis. Triggering is critical to capturing time domain information. The RSA offers unique trigger functionality, providing power and frequency-mask triggers as well as the usual external and level-based triggers.

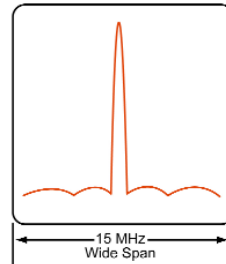

Figure 2-4: Wide capture bandwidth example.

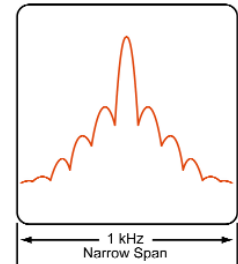

Figure 2-5: Narrow capture bandwidth example.

The most common trigger system is the one used in most oscilloscopes. In traditional analog oscilloscopes, the signal to be observed is fed to one input while the trigger is fed to another. The trigger event causes the start of a horizontal sweep while the amplitude of the signal is shown as a vertical displacement superimposed on a calibrated graticule. In its simplest form, analog triggering allows events that happen after the trigger to be observed, as shown in Figure 2-6 (next page).

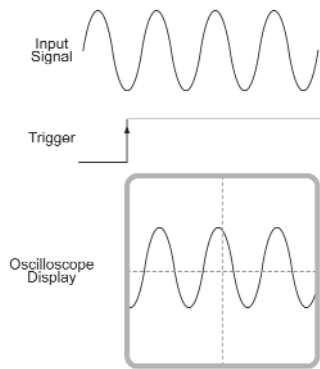

Figure 2-6: Traditional oscilloscope triggering.

Triggering in Systems with Digital Acquisition

The ability to represent and process signals digitally, coupled with large memory capacity, allows the capture of events that happen before the trigger as well as after it.

Digital acquisition systems of the type used in Tektronix RSAs use an Analog-to-Digital Converter (ADC) to fill a deep memory with time samples of the received signal. Conceptually, new samples are continuously fed to the memory while the oldest samples fall off. The example shown in Figure 2-7 shows a memory configured to store N samples. The arrival of a trigger stops the acquisition, freezing the contents of the memory. The addition of a variable delay in the path of the trigger signal allows events that happen before a trigger as well as those that come after it to be captured.

Consider a case in which there is no delay. The trigger event causes the memory to freeze immediately after a sample concurrent with the trigger is stored. The memory then contains the sample at the time of the trigger as well as “ N ” samples that occurred before the trigger. Only **pre-trigger** events are stored.

Consider now the case in which the delay is set to match exactly the length of the memory. “ N ” samples are then allowed to come into the memory after the trigger occurrence before the memory is frozen. The memory then contains “ N ” samples of signal activity after the trigger. Only **post-trigger** events are stored.

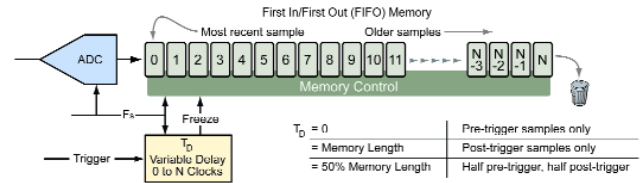

Figure 2-7: Triggering in digital acquisition systems.

Both post and pre-trigger events can be captured if the delay is set to a fraction of the memory length. If the delay is set to half of the memory depth, half of the stored samples are those that preceded the trigger and half the stored samples followed it. This concept is similar to a trigger delay used in zero span mode of a conventional swept SA. The RSA can capture much longer time records, however, and this signal data can subsequently be analyzed in the frequency, time, and modulation domains. This is a powerful tool for applications such as signal monitoring and device troubleshooting.

Trigger Modes and Features

The **free-run mode** acquires samples of the received IF signal without the consideration of any trigger conditions. Spectrum, modulation or other measurements are displayed as they are acquired and processed.

The **triggered mode** requires a trigger source as well as the setting of various parameters that define the conditions for triggering as well as the instrument behavior in response to a trigger.

A selection of **continuous** or **single trigger** determines whether acquisitions repeat each time a trigger occurs or are taken only once each time a measurement is armed. The **trigger position**, adjustable from 0 to 100%, selects which portion of an acquisition block is pre-trigger. A selection of 10% captures pre-trigger data for one tenth of the selected block and post-trigger data for nine tenths. **Trigger slope** allows the selection of rising edges, falling

Fundamentals of Real-Time Spectrum Analysis

► Primer

Trigger Source	Trigger Signal	Setting Units	Time Resolution	Notes
External	External trigger connector signal	TTL level	Time domain points (based on effective sampling rate)	External control signals
Level	Level comparator at A/D output	% A/D Full Scale	Time domain points (based on effective sampling rate)	Full IF bandwidth
Power	Power calculation at DDC/Decimator output	dB Full Scale relative to the top graticule	Time domain points (based on) effective sampling rate	Bandwidth defined by the span setting
Frequency mask	Point by point comparison at the output of a FFT Processor	dB and Hz, based on the graphical mask drawn on screen	Frame length (based on effective sampling rate)	Flexible mask profile defined by user

Table 2-3: Comparison of RSA trigger sources.

edges or their combination for triggering. Rise and fall allows the capture of complete bursts. Fall and rise allows the capture of gaps in an otherwise continuous signal.

RSA Trigger Sources

Tektronix RSAs provide several methods of internal and external triggering. Table 2-3 summarizes the various real-time trigger sources, their settings, and the time resolution that is associated with each one.

External triggering allows an external TTL signal to control the acquisition. This is typically a control signal such as a frequency switching command from the system under test. This external signal prompts the acquisition of an event in the system under test.

Internal triggering depends on the characteristics of the signal being tested. The RSA has the ability to trigger on the **level** of the digitized signal, on the **power** of the signal after filtering and decimation, or on the occurrence of specific spectral components using the **frequency mask trigger**. Each of the trigger sources and modes offers specific advantages in terms of frequency selectivity, time resolution and dynamic range. The functional elements that support these features are shown in Figure 2-8 (next page).

Level triggering compares the digitized signal at the output of the ADC with a user-selected setting. The full bandwidth of the digitized signal is used, even when observing narrow spans that require further filtering and decimation. Level triggering uses the full

digitization rate and can detect events with durations as brief as one sample at the full sampling rate. The time resolution of the downstream analyses, however, is limited to the decimated effective sampling rate. The trigger level is set as a percentage of the ADC clip level, that is, its maximum binary value (all “ones”). This is a linear quantity not to be confused with the logarithmic display, which is expressed in dB.

Power triggering calculates the power of the signal after filtering and decimation. The power of each filtered pair of I/Q samples (I^2+Q^2) is compared with a user-selected power setting. The setting is in dB relative to full scale (dBfs) as shown on the logarithmic screen. A setting of 0 dBfs places the trigger level at the top graticule and will generate a trigger when the total power contained in the span exceeds that trigger level. A setting of -10 dBfs will trigger when the total power in the span reaches a level 10 dB below the top graticule. Note that the total power in the span generates a trigger. Two CW signals each at a level of -3 dBm, for example, have an aggregate power of 0 dBm.

Frequency mask triggering compares the spectrum shape to a user-defined mask. This powerful technique allows changes in a spectrum shape to trigger an acquisition. Frequency mask triggers can reliably detect signals far below full-scale even in the presence of other signals at much higher levels. This ability to trigger on weak signals in the presence of strong ones is critical for detecting intermittent signals, the presence of inter-modulation products,

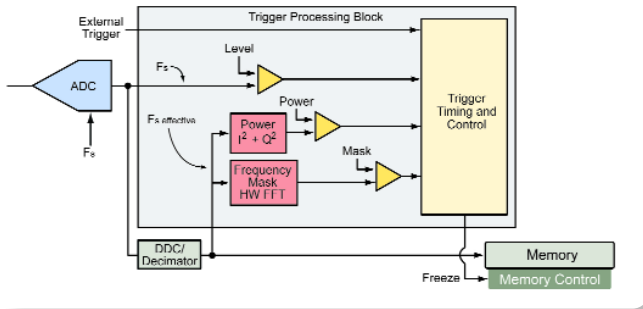

Figure 2-8: Real-time spectrum analyzer trigger processing.

transient spectrum containment violations and much more. A full FFT is required to compare a signal to a mask, requiring a complete frame. The time resolution for frequency mask trigger is roughly one FFT frame, or 1024 samples at the effective sampling rate. Trigger events are determined in the frequency domain using a dedicated hardware FFT processor, as shown in the block diagram in Figure 2-8.

Constructing a Frequency Mask

Like other forms of mask testing, the frequency mask trigger (also known as frequency domain trigger) starts with a definition of on-screen mask. This definition is done with a set of frequency points and their amplitudes. The mask can be defined point-by-point or graphically by drawing it with a mouse or other pointing device. Triggers can be set to occur when a signal outside the mask boundary “breaks in,” or when a signal inside the mask boundary “breaks out.”

Figure 2-9 shows a frequency mask defined to allow the passage of the normal spectrum of a signal but not momentary aberrations. Figure 2-10 shows a spectrogram display for an acquisition that was triggered when the signal momentarily exceeded the mask. Figure 2-11 (next page) shows the spectrum for one the first frame where the mask was exceeded. Note that pre-trigger and post-trigger data were collected and are both shown in the spectrogram.

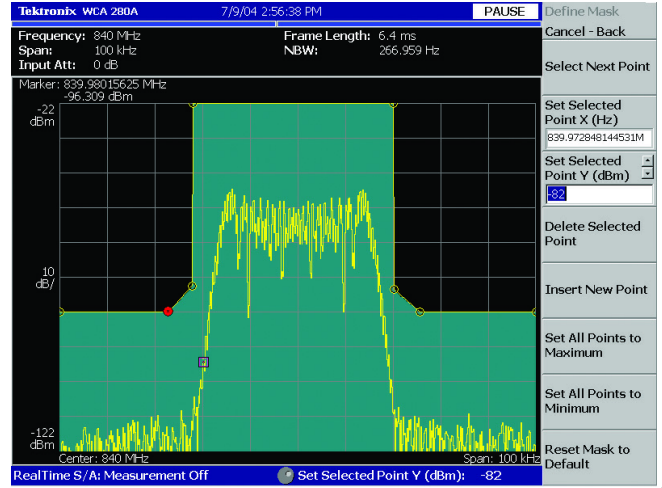

Figure 2-9: Frequency mask definition.

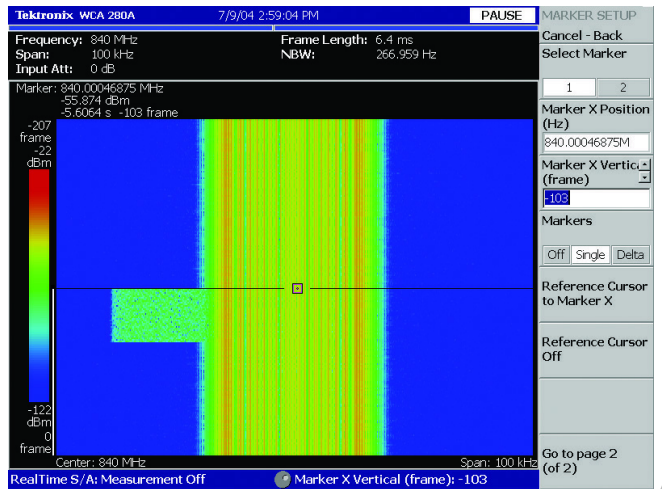

Figure 2-10: Spectrogram showing a transient signal adjacent to the carrier. The cursor is set to the trigger point, so pre-trigger data is displayed above the cursor line, and post-trigger data is displayed below the cursor line. The narrow white line at the left of the blue area denotes post-trigger data.

Fundamentals of Real-Time Spectrum Analysis

► Primer

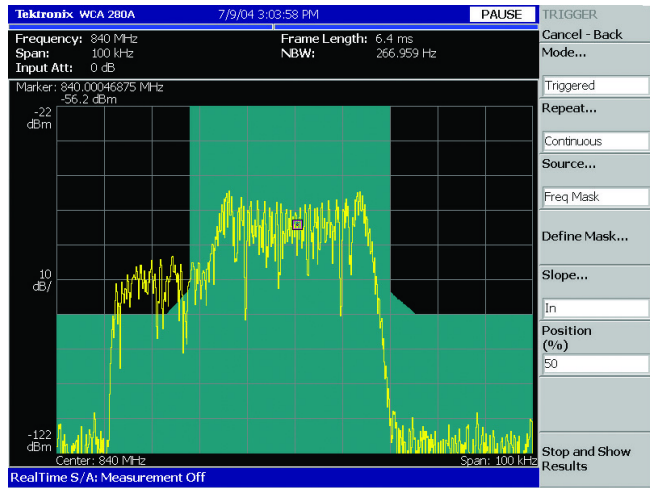

Figure 2-11: One frame of the spectrogram showing the trigger event where the transient signal breaks the boundary of the frequency mask.

Timing and Triggers

The timing controls, when used in conjunction with triggers offer a powerful combination for analyzing transient or other timing related parameters.

The **acquisition length** specifies the length of time for which samples will be stored in memory in response to a trigger. The **acquisition history** determines how many previous acquisitions will be kept after each new trigger. Tektronix RSAs show the entire acquisition length in the time-domain overview window.

The **spectrum length** determines the length of time for which spectrum displays are calculated. The **spectrum offset** determines the delay or advance from the instant of the trigger event until the beginning of the FFT frame that is displayed. Both spectrum length and spectrum offset have a time resolution of one FFT frame (1024 samples at the effective sample rate). Tektronix RSAs indicate the spectrum offset and spectrum length using a colored bar at the bottom of the time domain overview window. The bar color is keyed to the pertinent display.

The **analysis length** determines the length of time for which modulation analysis and other time based measurements are made. The **analysis offset** determines the delay or advance from the instant of the trigger until the beginning of the analysis. Tektronix RSAs

indicate the analysis offset and length using a colored bar at the bottom of the time domain overview window. The bar color is keyed to the pertinent display.

The **output trigger indicator** allows the user to selectively enable a TTL rear panel output at the instant of a trigger. This can be used to synchronize RSA measurements with other instruments such as oscilloscopes or logic analyzers.

Baseband DSP

Virtually all Real-Time Spectrum Analyzer measurements are performed through Digital Signal Processing (DSP) of the I and Q data streams generated by the DDC/Decimation block and stored into acquisition memory. The following is a description of some of the main functional blocks that are implemented with DSP.

Calibration/Normalization

Calibrations and normalizations compensate for the gain and frequency response of the analog circuitry that precedes the A/D converter. Calibrations are performed at the factory and stored in memory as calibration tables. Corrections from the stored tables are applied to measurements as they are computed. Calibrations provide accuracy traceable to official standards bodies. Normalizations are measurements that are performed internally to correct for variations caused by temperature changes, aging and unit-to-unit differences. Like calibrations, normalization constants are stored in memory and applied as corrections to measurement computations.

Filtering

Many measurements and calibration processes require filtering in addition to the filters in the IF and DDC/decimator. Filtering is done numerically on the I and Q samples stored in memory.

Timing, Synchronization and Re-sampling

Timing relationships among signals are critical to many modern RF systems. Tektronix RSAs provide time-correlated analysis of spectrum, modulation and power allowing the time relationships between various RF characteristics to be measured and studied. Clock synchronization and signal re-sampling are needed for demodulation and pulse processing.

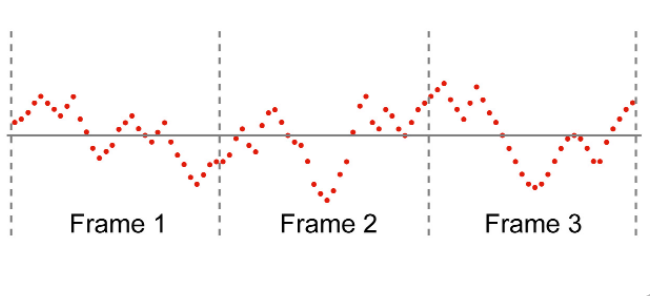

Figure 2-12: Three frames of a sampled time domain signal.

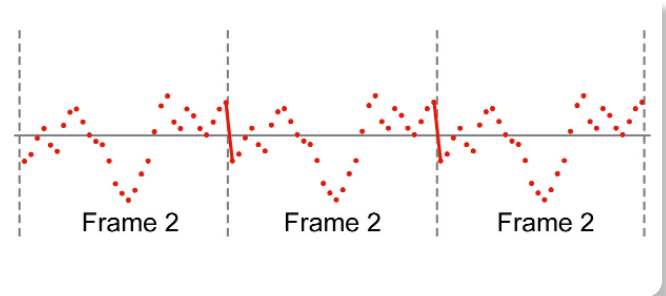

Figure 2-13: Discontinuities caused by periodic extension of samples in a single frame.

Fast Fourier Transform Analysis

The Fast Fourier Transform (FFT) is the heart of the real-time spectrum analyzer. In the RSA, FFT algorithms are generally employed to transform time-domain signals into frequency-domain spectra. Conceptually, FFT processing can be considered as passing a signal through a bank of parallel filters with equal frequency resolution and bandwidth. The FFT output is generally complex-valued. For spectrum analysis, the amplitude of the complex result is usually of most interest.

The FFT process starts with properly decimated and filtered base-band I and Q components, which form the complex representation of the signal with I as its real part and Q as its imaginary part. In FFT processing, a set of samples of the complex I and Q signals are processed at the same time. This set of samples is called the FFT frame. The FFT acts on a sampled time signal and produces a sampled frequency function with the same length. The number of samples in the FFT, generally a power of 2, is also called the FFT size. For example, 1024 point FFT can transform 1024 I and 1024 Q samples into 1024 complex frequency-domain points.

FFT Properties

The amount of time represented by the set of samples upon which the FFT is performed is called the frame length in the RSA. The frame length is the product of the FFT size and the sample period. Since the calculated spectrum is the frequency representation of the signal over the duration of the frame length, temporal events can not be resolved within the frame length from the corresponding spectrum. Therefore, the frame length is the time resolution of the FFT process.

The frequency domain points of FFT processing are often called FFT bins. Therefore, the FFT size is equal to the number of bins in one FFT frame. Those bins are equivalent to the individual filter output

in the previous discussion of parallel filters. All bins are spaced equally in frequency. Two spectral lines closer than the bin width cannot be resolved. The FFT frequency resolution is therefore the width of each frequency bin, which is equal to the sample frequency divided by the FFT size. Given the same sample frequency, a larger FFT size yields finer frequency resolution. For an RSA with a sample rate of 25.6 MHz and an FFT size of 1024, the frequency resolution is 25 kHz.

Frequency resolution can be improved by increasing the FFT size or by reducing the sampling frequency. The RSA, as mentioned above, uses a Digital Down Converter and Decimator to reduce the effective sampling rate as the frequency span is narrowed, effectively trading time resolution for frequency resolution while keeping the FFT size and computational complexity to manageable levels. This approach allows fine resolution on narrow spans without excessive computation time on wide spans where coarser frequency resolution is sufficient. The practical limit on FFT size is often display resolution, since an FFT with resolution much higher than the number of display points will not provide any additional information on the screen of the instrument.

Windowing

There is an assumption inherent in the mathematics of Discrete Fourier Transforms and FFT analysis that the data to be processed is a single period of a periodically repeating signal. Figure 2-12 depicts a series of time domain samples. When FFT processing is applied to Frame 2, for example, the periodic extension is made to the signal. The discontinuities between successive frames will generally occur as shown in Figure 2-13.

These artificial discontinuities generate spurious responses not present in the original signal, which can make it impossible to detect small signals in the presence of nearby large ones. This effect is called spectral leakage.

Fundamentals of Real-Time Spectrum Analysis

► Primer

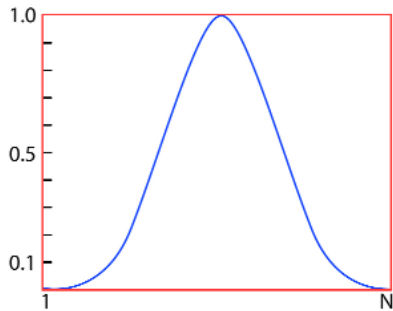

Figure 2-14: Blackman-Harris 4B (BH4B) window profile.

Tektronix RSAs apply a windowing technique to the FFT frame before FFT processing is performed to reduce the effects of spectral leakage. The window functions usually have a bell shape. There are numerous window functions available. The popular Blackman-Harris 4B(BH4B) profile is shown in Figure 2-14.

The Blackman-Harris 4B windowing function shown in Figure 2-11 has a value of zero for the first and last samples and a continuous curve in between. Multiplying the FFT frame by the window function reduces the discontinuities at the ends of the frame. In the case of the Blackman-Harris window, we can eliminate discontinuities altogether.

The effect of windowing is to place a higher weight to the samples in the center of the window than those away from the center, bringing the value to zero at the ends. This can be thought of as effectively reducing the time over which the FFT is calculated.

Time and frequency are reciprocal quantities. A smaller time sample implies poorer (wider) frequency resolution. For Blackman-Harris 4B windows, the effective frequency resolution is approximately twice as wide as the value achieved without windowing.

Another implication of windowing is that the time-domain data modified by this window produces an FFT output spectrum that is most sensitive to behavior in the center of the frame, and insensitive to behavior at the beginning and end of the frame. Transient signals appearing close to either end of the FFT frame are de-emphasized and can be missed altogether. This problem can be resolved by use of overlapping frames, a complex technique involving trade-offs between computation time and time-domain flatness in order to achieve the desired performance. This is briefly described below.

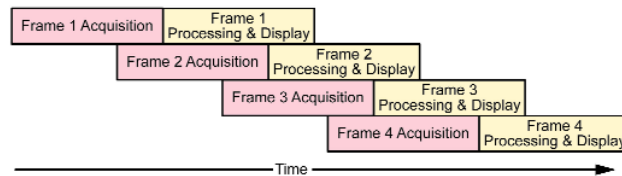

Figure 2-15: Signal acquisition, processing, and display using overlapping frames.

Post-FFT Signal Processing

Because the window function attenuates the signal at both ends of the frame, it reduces the overall signal power, the amplitude of the spectrum measured from the FFT with windowing must be scaled to deliver a correct amplitude reading. For a pure sine wave signal, the scaling factor is the DC gain of the window function.

Post processing is also used to calculate the spectrum amplitude by summing the squared real part and the squared imaginary part at each FFT bin. The spectrum amplitude is generally displayed in the logarithmic scale so different frequencies with wide-ranging amplitudes can be simultaneously displayed on the same screen.

Overlapping Frames

Some Real-Time Spectrum Analyzers can operate in real-time mode with overlapping frames. When this happens, the previous frame is being processed at the same time the new frame is being acquired. Figure 2-15 shows how frames are acquired and processed.

One benefit of overlapping frames is an increased display update rate, an effect that is most noticeable in narrow spans requiring long acquisition times. Without overlapping frames, the display screen cannot be updated until an entire new frame is acquired. With overlapping frames, new frames are displayed before the previous frame is finished.

Another benefit is a seamless frequency domain display in the spectrogram display. Since the windowing filter reduces the contribution of the samples at each end of a frame to zero, spectral events happening at the joint between two adjacent frames can be lost if the frames do not overlap. However, having frames that overlap ensures that all spectral events will be visible on the spectrogram display regardless of windowing effects.

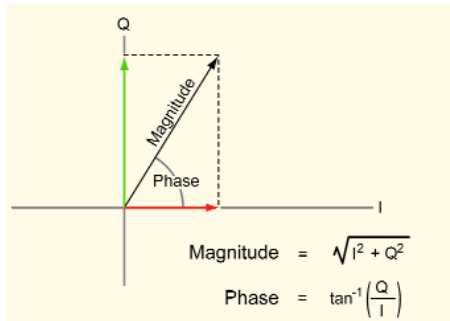

Figure 2-16: Vector representation of magnitude and phase.

Modulation Analysis

Modulation is the means through which RF signals carry information. Modulation analysis using the Tektronix RSA not only extracts the data being transmitted but also measures the accuracy with which signals are modulated. Moreover, it quantifies many of the errors and impairments that degrade modulation quality.

Modern communications systems have dramatically increased the number of modulation formats in use. The RSA is capable of analyzing the most common formats and has an architecture that allows for the analysis of new formats as they emerge.

Amplitude, Frequency and Phase Modulation

RF carriers can transport information in many ways based on variations in the amplitude or phase of the carrier. Frequency is the time derivative of phase. Frequency Modulation (FM) is therefore the time derivative of Phase Modulation (PM). Quadrature Phase Shift Keying (QPSK) is a digital modulation format in which the symbol decision points occur at multiple of 90 degrees of phase. Quadrature Amplitude Modulation (AM) is a high-order modulation format in which both amplitude and phase are varied simultaneously to provide multiple states. Even highly complex modulation formats such as Orthogonal Frequency Division Multiplexing (OFDM) can be decomposed into magnitude and phase components.

Magnitude and phase can be thought of as the length and the angle of a vector in a polar coordinate system. The same point can be expressed in Cartesian or rectangular coordinates (X,Y). The I/Q format of the time samples stored in memory by the RSA are mathematically equivalent to Cartesian coordinates with I representing the horizontal or X component and Q the vertical or Y component.

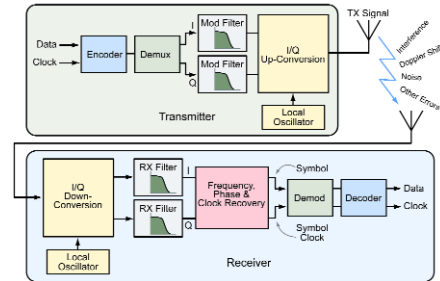

Figure 2-17: Typical digital communications system.

Figure 2-16 illustrates the magnitude and phase of a vector along with its I and Q components. AM demodulation consists of computing the instantaneous magnitude for each I/Q sample stored in memory and plotting the result over time. PM demodulation consists of computing the phase angle of the I and Q samples in memory and plotting them over time after accounting for the discontinuities of the arctangent function at $\pm\pi/2$. Once the phase trajectory or PM is computed for a time record, FM can be calculated by taking the time derivative.

Digital Modulation

Figure 2-17 shows the signal processing in a typical digital communications system. The transmit process starts with the data to be sent and a clock. The data and clock are passed through an encoder that re-arranges the data, adds synchronization bits, and does error recovery encoding and scrambling. The data is then split into I and Q paths and filtered, changing it from bits to analog waveforms which are then up-converted to the appropriate channel and transmitted over the air. Once transmitted, the signal inevitably suffers degradations from the environment before it is received.

The process of reception is the reverse of transmission with some additional steps. The RF signal is down-converted to I and Q base-band signals which are passed through RX filters often designed to remove inter-symbol interference. The signal is then passed through an algorithm that recovers the exact frequency, phase and data clock. This is necessary to correct for multi-path delay and Doppler shift in the path and for the fact that the RX and TX local oscillators are not usually synchronized. Once frequency, phase and clock are recovered, the signal is demodulated and decoded, errors are corrected and bits are recovered.

Fundamentals of Real-Time Spectrum Analysis

► Primer

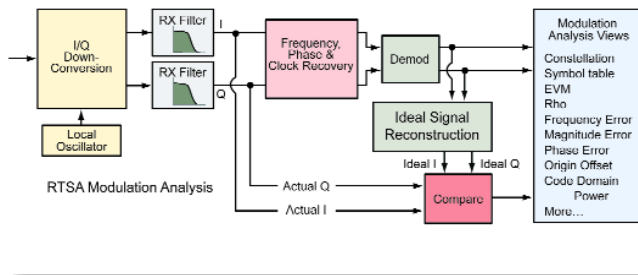

Figure 2-18: RSA modulation analysis block diagram.

The varieties of digital modulation are numerous and include the familiar FSK, BPSK, QPSK, GMSK, QAM, OFDM and others. Digital modulation is often combined with channel assignments, filtering, power control, error correction and communications protocols to encompass a particular digital communication standard whose purpose is to transmit error-free bits of information between radios at opposite ends of a link. Much of the complexity incurred in a digital communication format is necessary to compensate for the errors and impairments that enter the system as the signal travels over the air.

Figure 2-18 illustrates the signal processing steps required for a digital modulation analysis. The basic process is the same as that of a receiver except that recovered symbols are used to reconstruct the mathematically ideal I and Q signals. These ideal signals are compared with the actual or degraded I and Q signals to generate the required modulation analysis views and measurements.

Power Measurements and Statistics

Tektronix RSAs can perform power measurements both in the frequency domain and in the time domain. Time domain measurements are made by integrating the power in the I and Q baseband signals stored in memory over a specified time interval. Frequency domain measurements are made by integrating the power in the spectrum over a specified frequency interval. Channel filters, required for many standards-based measurements, may be applied to yield the resultant channel power. Calibration and normalization parameters are also applied to maintain accuracy under all specified conditions.

Communications standards often specify statistical measurements for components and end-user devices. RSAs have measurement routines to calculate statistics such as the Complementary Cumulative Distribution Function (CCDF) of a signal which is often used to characterize the peak-to-average power behavior of complex modulated signals.

Fundamentals of Real-Time Spectrum Analysis

► Primer

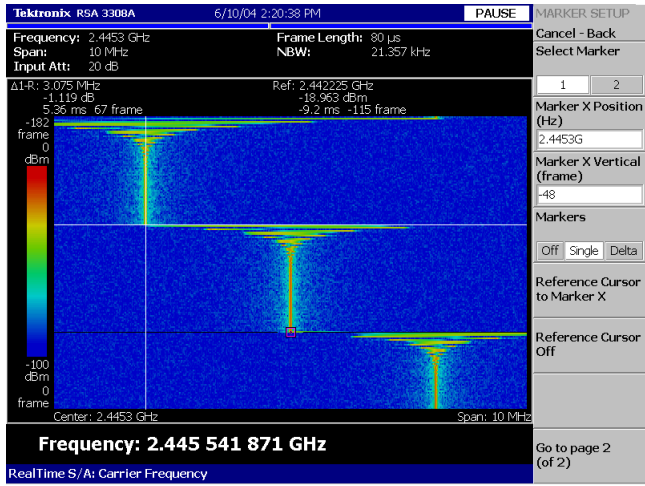

Figure 3-1: Real-Time SA mode showing spectrogram of frequency hopping signal.

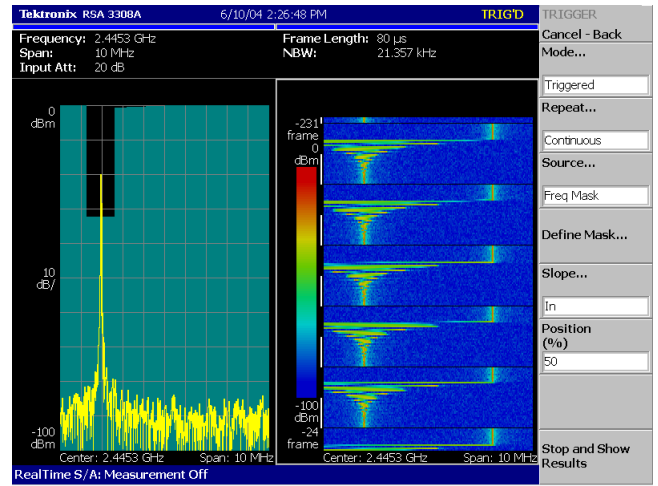

Figure 3-2: Real-Time SA mode showing several blocks acquired using a frequency mask trigger to measure the repeatability of frequency switching transients.

Chapter 3: Real-Time Spectrum Analyzer Measurements

This chapter describes the operational modes and measurements of RSAs. Several pertinent details such as the sampling rate and the number of FFT points are product dependent. Like the other measurement examples in this document, the information in this section applies specifically to the Tektronix RSA3300A Series and WCA200A Series of Real-Time Spectrum Analyzers.

Frequency Domain Measurements

Real-Time SA

This is the mode described in the discussion of seamless capture with spectrogram in Chapter 1. It provides real-time seamless capture, real-time triggering, and the ability to analyze captured time domain data using the power vs. frequency display and the spectrogram display. This mode also provides several automated measurements such as the carrier frequency measurement shown in Figure 3-1.

As explained in Chapter 1, the spectrogram has three axes:

- The horizontal axis represents frequency
- The vertical axis represents time
- The color represents amplitude

When combined with real-time triggering capabilities, as shown in Figure 3-2, the spectrogram becomes an even more powerful measurement tool for dynamic RF signals.

Here are a few key points to remember when using the spectrogram display:

- Frame time is span-dependent (wider span = shorter time).
- One vertical line of the spectrogram = one real-time frame.
- One real-time frame = 1024 time domain samples.
- The oldest frame is at the top of the screen, the most recent is at the bottom.
- The data within a block is seamlessly captured and contiguous in time.
- Horizontal black lines on the spectrogram represent boundaries between blocks. These are the gaps in time that occur between acquisitions.
- The white bar on left side of the spectrogram display denotes post-trigger data.

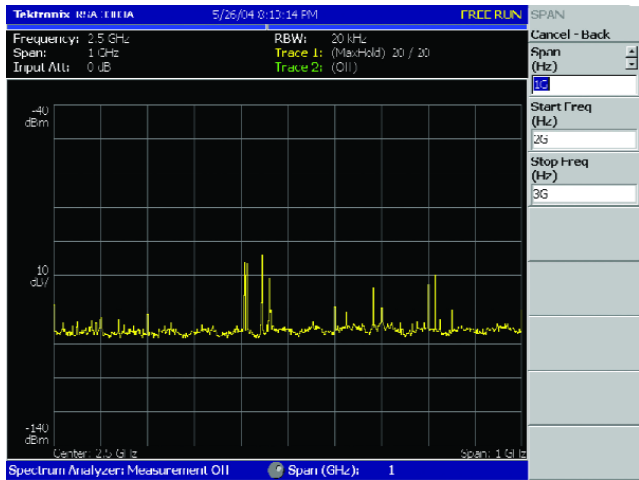

Figure 3-3: Standard SA mode showing an off-the-air measurement over a 1 GHz frequency span using max hold.

Standard SA

Standard SA mode, shown in Figure 3-3, provides frequency domain measurements that emulate a traditional swept SA. For frequency spans that exceed the real-time bandwidth of the instrument, this is achieved by tuning the RSA across the span of interest much like a traditional spectrum analyzer (the acquisition section at the end of this chapter describes this in further detail). This mode also provides adjustable RBWs, averaging functions, and the ability to adjust FFT and windowing settings. Real-time triggers and real-time seamless capture are not available in standard SA mode.

SA with Spectrogram

SA with Spectrogram mode provides the same functionality as standard SA mode with the addition of a spectrogram display. Again, this mode allows the user to select a span greater than the maximum real-time acquisition bandwidth of the RSA. Unlike Real-Time SA mode, though, SA with Spectrogram mode has no real-time triggering, no seamless capture, and the data is not stored in the memory of the instrument. This makes it impossible to scroll back in time through data displayed on the spectrogram.

Time Domain Measurements

Frequency vs. Time

The Frequency vs. Time measurement displays frequency on the vertical axis and time on the horizontal axis. It provides a similar

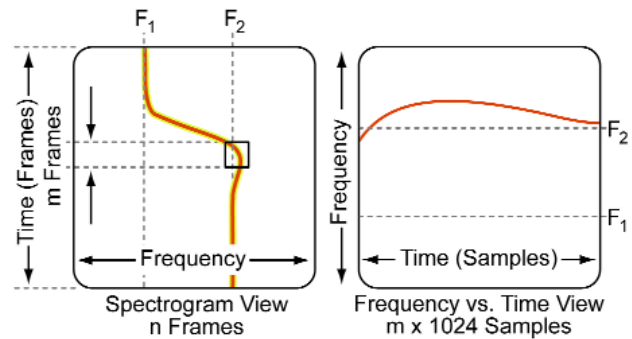

Figure 3-4: Comparison of spectrogram and frequency vs. time views.

result to what is shown on the spectrogram display, with two important differences. First, the frequency vs. time view has much better time domain resolution than the spectrogram, as described in detail below. Second, this measurement calculates a single average frequency value for every point in time, which means that it cannot display multiple RF signals like the spectrogram can.

The spectrogram is a compilation of frames and has a line-by-line time resolution equal to the length of one frame and the frequency vs. time view has a time resolution of one sample interval. Assuming 1024 samples in a frame, the resolution in this mode is 1024 times finer than that of the spectrogram. This makes it easy to see small, brief frequency shifts in great detail. The view acts almost like a very fast frequency counter. Each of the 1024 sample points represents a frequency value, whether the span is a few hundred hertz or many megahertz. Constant-frequency signals such as CW or AM produce a flat, level display.

The frequency vs. time view provides the best results when there is a relatively strong signal at one unique frequency. Figure 3-4 is a simplified illustration contrasting the frequency vs. time display with a spectrogram. The frequency vs. time display is in some ways a zoomed-in view that magnifies a portion of the spectrogram. This is

Fundamentals of Real-Time Spectrum Analysis

► Primer

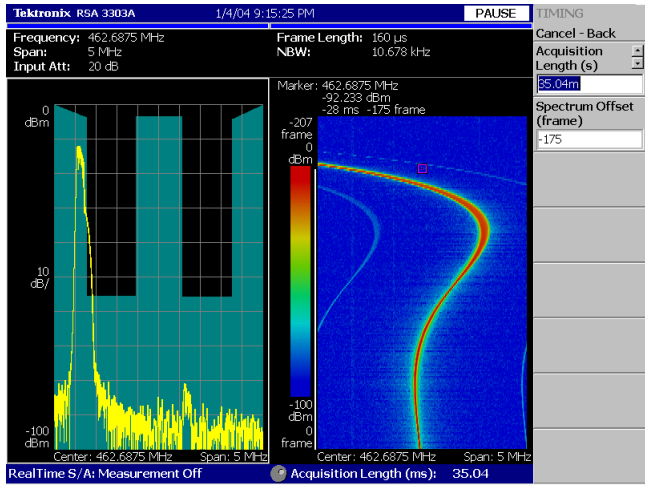

Figure 3-5: Spectrogram view of frequency settling over 5 MHz of frequency and 35 ms of time.

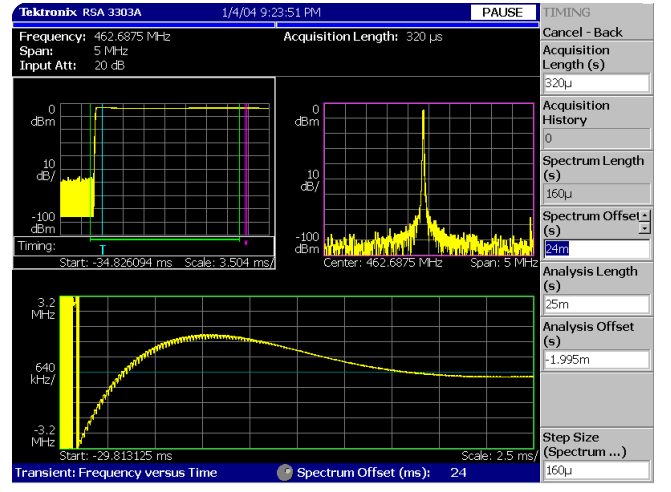

Figure 3-6: Frequency vs. time view of frequency settling over 5 MHz of frequency and 25 ms of time.

very useful for examining transient events such as frequency overshoot or ringing. When there are multiple signals in the measured environment, or one signal with an elevated noise level or intermittent spurs, the spectrogram remains the preferred view. It provides visualization of all the frequency and amplitude activity across the chosen span.

Figures 3-5, 3-6, and 3-7 show three different analysis views of the same acquisition. As shown in Figure 3-5, the frequency mask trigger was used to capture a transient signal coming from a transmitter having occasional problems with frequency stability during turn-on. Since the oscillator was not tuned to the frequency at the center of the screen, the RF signal broke the frequency mask shown on the left and caused a trigger. The spectrogram plot on the right shows the frequency settling behavior of the device.

The next two figures show frequency vs. time displays of the same signal, Figure 3-6 shows the same frequency settling behavior as the spectrogram using a 25 ms analysis length. Figure 3-7 shows the ability to zoom in to an analysis length of 1 ms, showing the changes in frequency over time with much finer time domain resolution. This reveals a residual oscillation on the signal even after it has settled to the correct frequency.

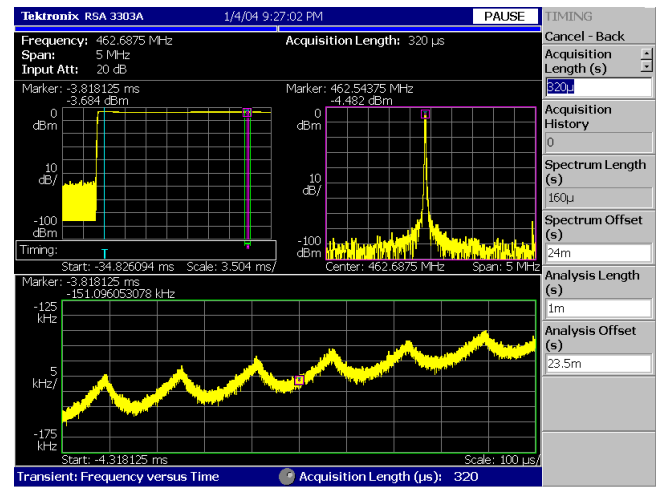

Figure 3-7: Zooming in to view frequency settling over 50 kHz of frequency and 1 ms of time.

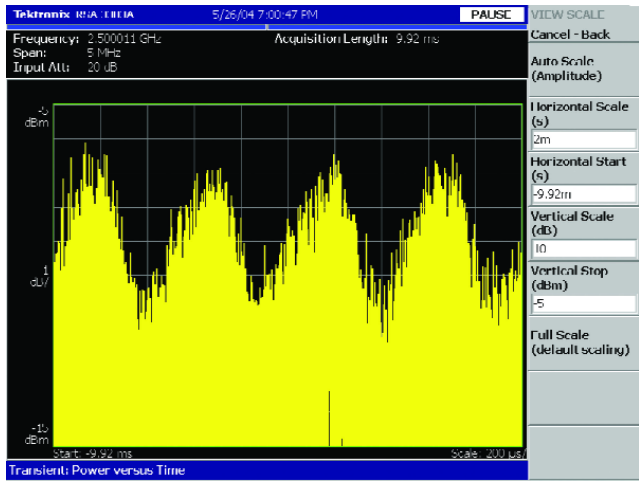

Figure 3-8: Power vs. time display.

Power vs. Time

The power vs. time display (Figure 3-8) shows how the power of a signal changes on a sample by sample basis. The amplitude of the signal is plotted in dBm on a logarithmic scale. This display is similar to an oscilloscope's time-domain view in that the horizontal axis represents time. In contrast, the vertical axis shows power on a log scale instead of voltage on a linear scale, and it represents the total power detected within the span. A constant power signal will yield a flat trace display since there is no average power change per cycle. For each time domain sample point, power is calculated as follows:

$$Power = 10 \cdot \log \frac{(I^2 + Q^2)}{1 \text{ mW}}$$

The power vs. time display is available in the overview window for all real-time measurements. It can also be shown in the analysis window using power vs. time mode.

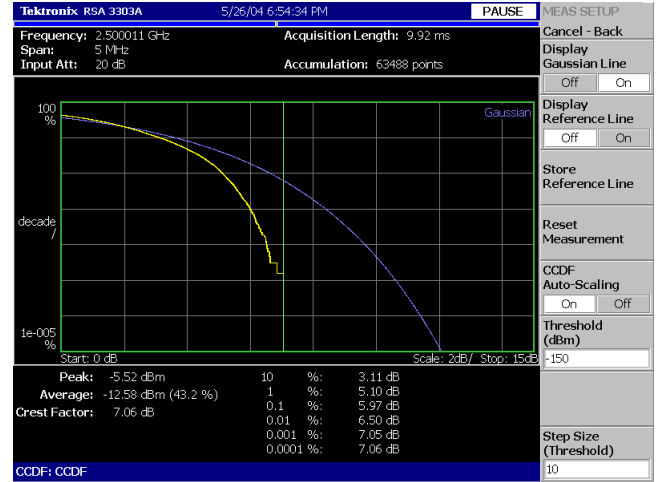

Figure 3-9: CCDF measurement.

Complementary Cumulative Distribution Function

The Complementary Cumulative Distribution Function (CCDF) view displays the probability that peak power above average power on the measured signal exceeds the amplitude displayed on the horizontal scale. Probability is displayed as a percent on the vertical scale. The vertical axis is logarithmic.

CCDF analysis measures the time-varying crest factor, which is important for many digital signals, especially those that use CDMA and OFDM. The crest factor is the ratio of a signal's peak voltage divided by its average voltage, with the result expressed in dB:

$$C = 20 \cdot \log \left(\frac{V_{peak}}{V_{rms}} \right)$$

The crest factor of the signal determines how linear a transmitter or receiver must be in order to avoid unacceptable levels of signal distortion. The CCDF curves shown in Figure 3-9 shows the measured signal in yellow and a Gaussian reference trace in blue. The CCDF and crest factor are especially interesting to designers who must balance power consumption and distortion performance of devices such as amplifiers.

Fundamentals of Real-Time Spectrum Analysis

► Primer

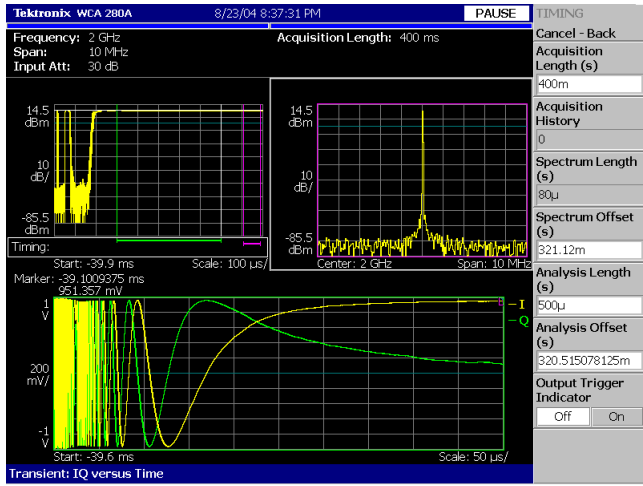

Figure 3-10: I/Q vs. Time measurement of settling transient.

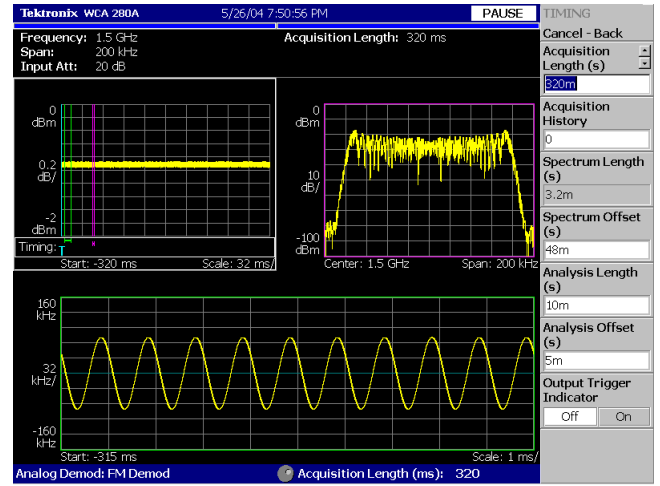

Figure 3-12: FM demod analysis of a signal being modulated by a sine wave.

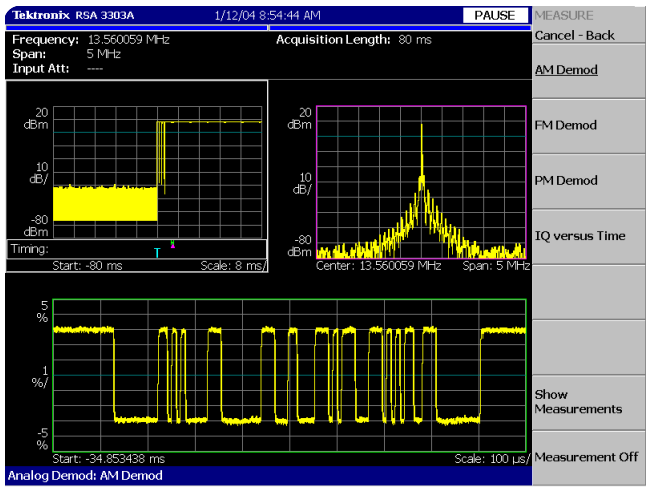

Figure 3-11: AM demod analysis of a pulsed signal using amplitude shift keying to encode data.

I/Q vs. Time

Transient I/Q vs. Time (Figure 3-10) is another time-domain view that displays the amplitudes of I and Q as a function of time. This measurement shows the raw I and Q output signals coming from the digital down-converter. As a result, this display is not synchronized to any modulation that might be present on the signal being analyzed, unlike the I/Q vs. Time measurement mode within the digital demodulation suite.

This measurement can be another useful troubleshooting tool for expert users, especially in terms of lending insight into frequency and phase errors and instabilities.

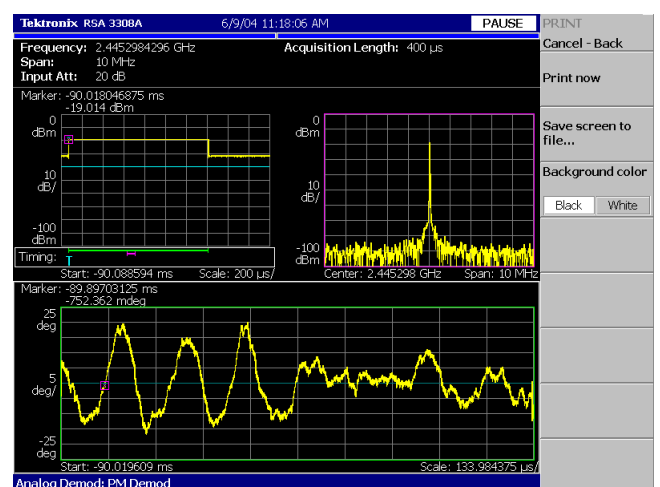

Figure 3-13: PM demod analysis showing phase instability over a long burst.

Modulation Domain Measurements

Analog Modulation Analysis

The analog demod mode provides measurements to demodulate and analyze amplitude modulation (Figure 3-11), frequency modulation (Figure 3-12), and phase modulation (Figure 3-13). Just like the time domain measurements, these tools are based on the concept of multi-domain analysis, and the spectrum and analysis windows can be positioned anywhere within the block shown in the overview window.

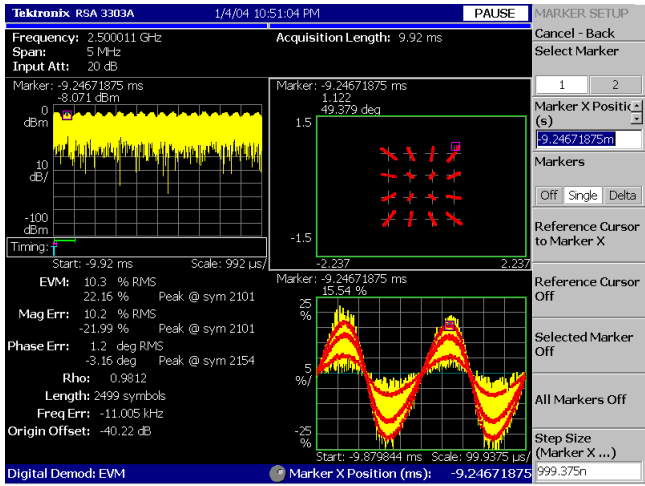

Figure 3-14: EVM analysis over time of 16 QAM signal reveals sinusoidal amplitude distortion.

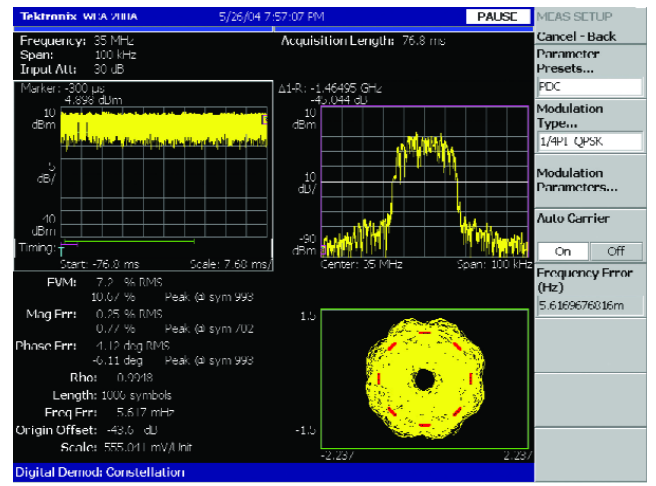

Figure 3-15: Constellation display showing phase instability in a PDC signal.

Digital Modulation Analysis

The digital demod mode can demodulate and analyze many common digital signals based on phase shift keying (PSK), frequency shift keying (FSK), and quadrature amplitude modulation (QAM). The RSA provides a wide range of measurements including: constellation, error-vector magnitude (EVM), magnitude error, phase error, demodulated I/Q vs. time, symbol table, and eye diagram. To make these measurements, it is necessary to properly configure variables such as the modulation type, symbol rate, measurement (receive) filter type and parameter (α /BT), and reference filter type.

The RSA provides a powerful solution for characterizing dynamic modulated signals by combining the digital demodulation measurements of a VSA with real-time triggering and time-correlated multi-domain analysis, as illustrated in Figures 3-14, 3-15, and 3-16.

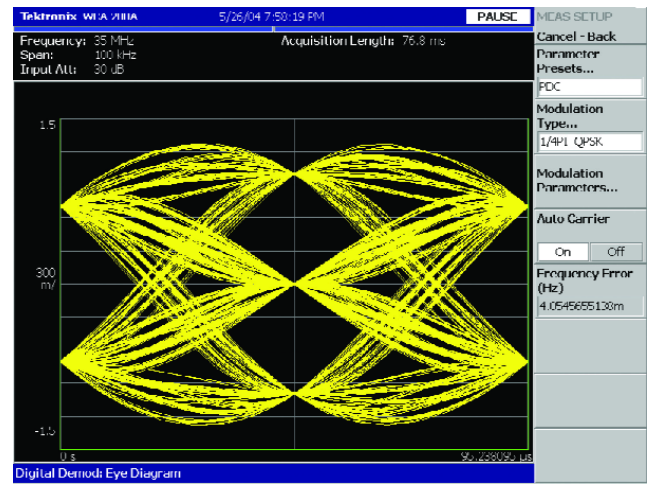

Figure 3-16: Eye Diagram display showing low magnitude error in a PDC signal.

Fundamentals of Real-Time Spectrum Analysis

► Primer

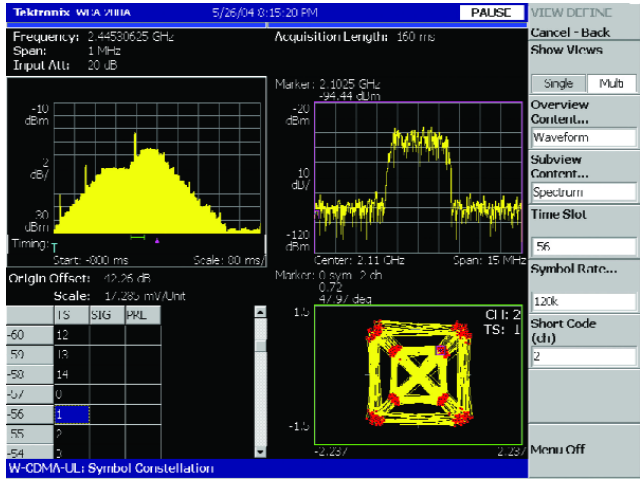

Figure 3-17: Modulation analysis of a W-CDMA handset under closed loop power control. The constellation display (lower right) shows the error associated with large glitches that occur during level transitions, which can be seen in the power vs. time display (upper left).

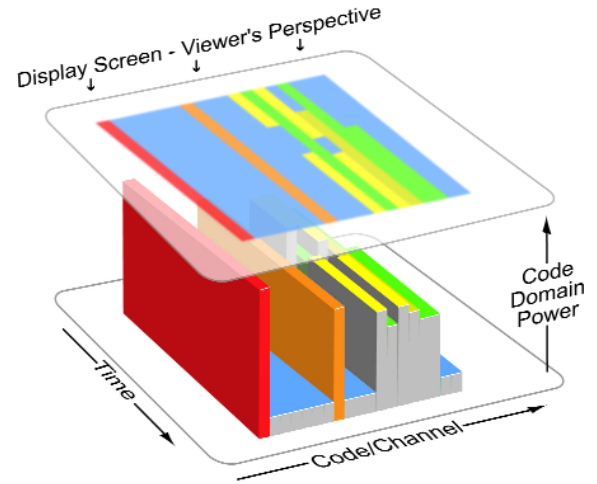

Figure 3-19: Illustration of the codogram display.

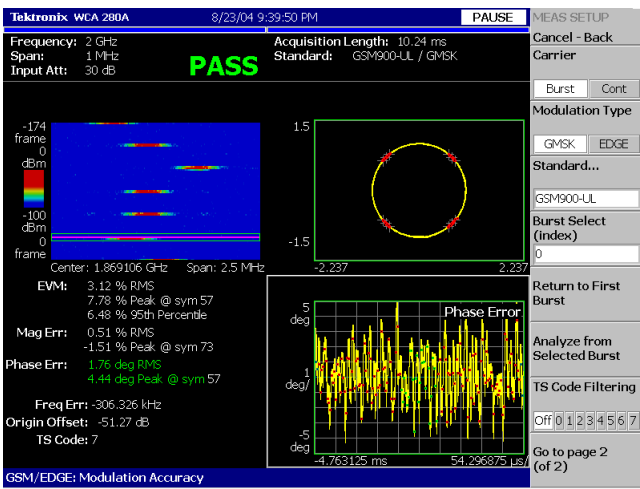

Figure 3-18: Spectrogram, constellation, EVM, and phase error vs. time of frequency hopping GSM signal.

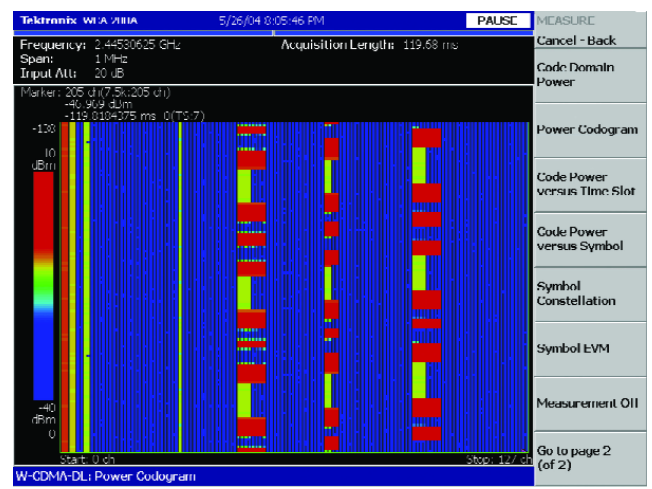

Figure 3-20: Codogram measurement of W-CDMA compressed mode.

Standards-based Modulation Analysis

The RSA also provides solutions for modulation analysis of many communications standards such as W-CDMA, HSDPA, GSM/EDGE, CDMA2000, 1xEV-DO, and more. Figures 3-17 and 3-18 show examples of standards-based modulation analysis.

Codogram Display

The codogram display (Figure 3-19) of the Real-Time Spectrum Analyzer adds a time axis to code domain power measurements for CDMA-based communications standards. Like the spectrogram, the codogram intuitively shows changes over time.

Figure 3-20 is a W-CDMA codogram display from an RSA. This particular codogram shows a simulated W-CDMA compressed mode handoff in which the data rate is momentarily increased to make room for brief, temporary gaps in the transmission. These gaps allow dual-mode W-CDMA/GSM user equipment to search for an available GSM base station while remaining connected to a W-CDMA Node B.

Frequently Asked Questions

► Primer

Chapter 4: Frequently Asked Questions

Real-Time spectrum analysis has existed in some form for many years, and as the technology enabling this architecture has matured, the RTSA has become a prevalent tool for a wide variety of applications that require the ability to characterize RF signals that change over time. This section addresses several of the frequently asked questions about real-time spectrum analysis.

What is real-time spectrum analysis?

The fundamental concept of real-time spectrum analysis is the ability to trigger on an RF signal, seamlessly capture it into memory, and analyze it in multiple domains. This makes it possible to reliably detect and characterize RF signals that change over time.

What is real-time bandwidth?

Instead of sweeping across a range of frequencies, the RTSA takes snapshots of all of the RF energy within the entire span. This span is known as the real-time acquisition bandwidth. By digitizing the signal and recording time domain I/Q samples, the RTSA can seamlessly capture signals that occur within its real-time bandwidth and analyze amplitude, frequency, phase, and modulation parameters at specific points in time.

The real-time bandwidth may be positioned anywhere within the absolute frequency range of the instrument. For example, the Tektronix RTSA3308A has a 15 MHz real-time bandwidth that can be tuned between DC and 8 GHz.

The maximum real-time bandwidth is an important figure of merit for an RTSA. It is typically limited by the sample rate of the instrument's ADCs and the bandwidth over which the instrument's IF section has a linear frequency and phase response.

What is real-time seamless capture?

The real-time architecture provides the ability to continuously capture an RF signal over a long period of time. An uninterrupted sequence of time domain samples is acquired and stored in the deep memory of the RTSA. This allows the instrument to create a time axis to accompany the usual frequency and amplitude axes, enabling displays such as the spectrogram. Having access to the

raw magnitude and phase representation of the signal also gives the RTSA the ability to perform complex signal analysis in the frequency, time, and modulation domains using FFTs and other DSP techniques to process the recorded time-domain samples.

Another important consequence is that as described above, all RF energy within the real-time acquisition bandwidth is digitized and recorded simultaneously. Contrast this to the swept spectrum analyzer, which tunes across the frequency span in narrow steps and assembles the results to create the spectral display. With the RTSA, the user can detect and characterize dynamic signals that occur anywhere within its real-time bandwidth at any time within the block of seamless time-domain information.

What is meant by “static” and “dynamic” signals?

Static or stationary signals are unchanging signals. Many spectrum analyzer measurements and communications standards call for known, well-behaved signals as inputs for the device under test. Other applications involve observing either basic CW signals or signals whose modulation type is well known and does not change.

Dynamic signals vary over time. They may change in amplitude, frequency, phase, or modulation type; or they may disappear and reappear at regular or unknown intervals. These types of RF signals can be important to detect and characterize in a variety of applications ranging from surveillance (where signals appear briefly and unpredictably) to phase locked loop design (where recovery time after frequency shifts must comply with design specifications).

Swept spectrum analyzers have difficulty making measurements on dynamic signals, although they may be able to show some information about signals that change slowly or predictably. However, the RTSA is specifically designed to trigger on, capture, and analyze dynamic signals and transient events.

Why does the RTSA power vs. frequency display look slightly different from that of a swept SA?

In the RTSA, full spans are acquired continuously, which means that in some cases screen updates can occur much more quickly than on a swept spectrum analyzer.

For spans within the real-time bandwidth, the RTSA acquires a block of data, processes it, then displays the entire range of frequencies at once. Consequently, each screen update is like a new photographic snapshot of the spectrum. The RTSA display also changes rapidly when signal amplitude and frequency characteristics change. Dynamic signals might look busy on the RTSA compared to a swept SA since the RTSA is displaying the signal changes as they actually happen.

With a swept SA, a filter equal to the width of the RBW filter setting moves through the spectrum. Signal amplitude at any frequency in the span is measured only when the sweeping window passes through that frequency. This window may be just a few percent of the total span but it is easy to locate the instantaneous frequency of the sweep. However, it is impossible to know whether an event such as a transient may be occurring elsewhere.

For spans exceeding its real-time bandwidth, the RTSA acquires and processes one segment of the span at a time, much like a swept SA. Its behavior in this mode is similar to the swept SA, although there may be significant speed differences due to the different methods of implementing RBW filters (usually analog in a swept SA, digital in the RTSA). For very wide measurement spans, the RTSA tends to be faster for narrow RBW settings, and the swept SA tends to be faster for wide RBW settings.

Applying a resolution bandwidth filter in standard SA mode makes the measured signals look different. Why?

The RTSA has all of its RBW filters implemented in DSP. Compared to common analog spectrum analyzers, the shape factors on these filters can be much steeper, producing a narrower appearance in the spectral content.

The steep RBW shape factor is an improvement over swept spectrum analyzers because low-level signals close to the carrier can be resolved. Phase noise is easier to see because it doesn't hide under a wide-RBW filter skirt.

Noise looks different on an RTSA. Can noise power be measured accurately?

In real-time acquisition modes, the RTSA takes rapid snapshots of the input RF signal. If it is to characterize fast changes in these RF signals, it must necessarily analyze the incoming signals over very short windows of time (frames). Therefore, it shows exactly the noise character of the spectrum represented in each frame. The traditional swept spectrum analyzer must sweep slowly, and therefore it is forced to average the noise as it sweeps across the entire frequency span. This longer "analysis time" of the swept SA is why it looks different than the display of the RTSA.

The noise bandwidth of the RTSA is very predictable since the FFT bin width is a known value determined by DSP. Therefore noise power spectral density can be measured accurately in any real-time span of the RTSA.

In standard SA acquisition modes, video filtering and display averaging are available to process the noise. In this case, display averaging will produce a noise signal shape that is very similar to that of a swept spectrum analyzer.

What is noise bandwidth?

Noise bandwidth (NBW) is the RTSA equivalent to the resolution bandwidth (RBW) of a swept spectrum analyzer. In its real-time modes, the RTSA's frequency resolution is expressed by its NBW. When it is in standard SA mode (which emulates a swept SA), the RTSA offers the same adjustable RBW settings as a traditional swept SA.

The NBW of a filter is determined by integrating the filter's normalized transfer function over all frequencies from zero to infinity, and relating the power the filter will transfer to an ideal 1Hz brick wall (rectangular) filter with a noise bandwidth of 1Hz.

Swept SAs typically use RBW filters that are characterized for noise bandwidth and corrected internally. Knowing the noise bandwidth is essential for measurements in which the signal itself is noise, or where it has noise-like power distribution (as in a CDMA transmission).

Frequently Asked Questions

► Primer

Span	Sample Rate	Decimation	Effective Sample Rate	Time Domain Resolution	Spectrogram Time Resolution	Maximum Record Length
15 MHz	51.2 MS/s	2	25.6 MS/s	39.0 ns	40 usec	2.56 sec
10 MHz	51.2 MS/s	4	12.8 MS/s	78.1 ns	80 usec	5.12 sec
5 MHz	51.2 MS/s	8	6.4 MS/s	156 ns	160 usec	10.2 sec
2 MHz	51.2 MS/s	16	3.2 MS/s	312 ns	320 usec	20.5 sec
1 MHz	51.2 MS/s	32	1.6 M/s	625 ns	640 usec	40.0 sec
500 KHz	51.2 MS/s	64	800 KS/s	1.25 us	1.28 msec	81.0 sec
200 KHz	51.2 MS/s	160	320 KS/s	3.13 us	3.20 msec	205 sec
100 KHz	51.2 MS/s	320	160 KS/s	6.25 us	6.40 msec	410 sec
50 KHz	51.2 MS/s	640	80 KS/s	12.5 us	12.8 msec	13.7 min
20 KHz	51.2 MS/s	1600	32 KS/s	31.3 us	32 msec	34.1 min
10 KHz	51.2 MS/s	3200	16 KS/s	62.5 us	64 msec	68.2 min
5 KHz	51.2 MS/s	6400	8 KS/s	125 us	128 msec	136.6 min
2 KHz	51.2 MS/s	16000	3.2 KS/s	312 us	320 msec	5.69 hour
1 KHz	51.2 MS/s	32000	1.6 KS/s	625 us	640 msec	11.4 hour
500 Hz	51.2 MS/s	64000	800 S/s	1.25 ms	1.28 sec	22.8 hour
200 Hz	51.2 MS/s	160000	320 S/s	3.13 ms	3.2 sec	2.37 day
100 Hz	51.2 MS/s	320000	160 S/s	6.25 ms	6.4 sec	4.74 day

Table 4-1: RTSA span selection and resulting time resolution effects. (Tektronix RSA3300A Series and WCA200A Series)

RTSA's use BH4B filtering in its real-time mode. Since filtering is done by DSP, it is possible to calculate the actual noise bandwidth and display it on the screen with the other instrument settings and measurement results. This method provides accurate noise measurements.

How does span affect time domain resolution of the RTSA?

As described in Chapter 3, the span setting of the RTSA determines the effective sample rate for the time domain data that is stored in the memory of the instrument. Table 4-1 illustrates the impact of increasing and decreasing the span.

Span	Sample Rate	Decimation	Effective Sample Rate	Frequency Resolution (FFT bin width)	Noise Bandwidth (NBW)
15 MHz	51.2 MS/s	2	25.6 MS/s	25 kHz	42.7 kHz
10 MHz	51.2 MS/s	4	12.8 MS/s	12.5 kHz	21.4 kHz
5 MHz	51.2 MS/s	8	6.4 MS/s	6.25 kHz	10.7 kHz
2 MHz	51.2 MS/s	16	3.2 MS/s	3.13 kHz	5.34 kHz
1 MHz	51.2 MS/s	32	1.6 MS/s	1.56 kHz	2.67 kHz
500 KHz	51.2 MS/s	64	800 KS/s	781 Hz	1.33 kHz
200 KHz	51.2 MS/s	160	320 KS/s	313 Hz	534 Hz
100 KHz	51.2 MS/s	320	160 KS/s	156 Hz	267 Hz
50 KHz	51.2 MS/s	640	80 KS/s	78.1 Hz	133 Hz
20 KHz	51.2 MS/s	1600	32 KS/s	31.3 Hz	53.4 Hz
10 KHz	51.2 MS/s	3200	16 KS/s	15.6 Hz	26.7 Hz
5 KHz	51.2 MS/s	6400	8 KS/s	7.81 Hz	13.3 Hz
2 KHz	51.2 MS/s	16000	3.2 KS/s	3.13 Hz	5.34 Hz
1 KHz	51.2 MS/s	32000	1.6 KS/s	1.56 Hz	2.67 Hz
500 Hz	51.2 MS/s	64000	800 S/s	781 mHz	1.33 Hz
200 Hz	51.2 MS/s	160000	320 S/s	312 mHz	534 mHz
100 Hz	51.2 MS/s	320000	160 S/s	156 mHz	267 mHz

Table 4-2: RTSA span selections and resulting frequency domain effects. (Tektronix RSA3300A Series and WCA200A Series)

How does span affect frequency domain resolution of the RTSA?

Digital down conversion and decimation have equally significant effects on the frequency domain resolution of the RTSA. The frequency resolution of a real-time measurement is defined by the width of the FFT bin and by the NBW for noise-like signals. Table 4-2 illustrates the impact of increasing and decreasing the span.

How does the general RF performance of RTSA compare to a swept spectrum analyzer?

The RTSA generally compares favorably with modern swept SAs that use digital IF sections. Here is an overview of the primary areas in which either type of analyzer can introduce measurement errors.

Real-Time Measurements: The swept spectrum analyzer has effectively no real-time capability, and consequently tends to introduce large errors for transient signals. The RTSA is optimized to trigger on, capture, and analyze transient or time-varying signals.

Distortion: Distortion processes for the swept SA and the RTSA are equivalent through the RF converter. After the RF converter, distortion in the RTSA is dependent on the ADC resolution as well as the bit width of the subsequent DSP operations. The fundamentals of ADC technology dictate tradeoffs between distortion performance and bandwidth. The RTSA is designed to achieve wide real-time bandwidths and consequently has less dynamic range than some high performance conventional swept SAs.

Spurs: Spurs may be generated in the wideband ADC, DDC, and FFT processing steps. However, all of these factors can be held to levels such that the net spurious performance of the RTSA is typically equivalent to that of swept SAs.

Thermal Noise and Phase noise: The dominant thermal noise and phase noise mechanisms are similar for both RTSAs and swept SAs.

Frequently Asked Questions

► Primer



Figure 4-1: Standard SA mode signal acquisition and processing.

Amplitude Flatness: The RF converter amplitude flatness is equivalent for RTSA and swept SA architectures. Because the RTSA relies on a wide-band IF filter and the digital filters in the DDC are optimized for transition-band performance, RTSA design requires special attention to counteract any deviations from flat response. In practice, the RTSA's amplitude flatness performance approximates that of swept SAs.

Detector and Log Errors: Neither the RTSA nor the modern swept SA is troubled by the detector and logarithmic errors found in older analog spectrum analyzers. Both of these modern instrument families use ADCs and DSP to accomplish detection and log scaling.

How does the RTSA make measurements in spans greater than the real-time bandwidth?

There are two different acquisition modes used in the Tektronix RTSA3300A Series and WCA200A Series:

- **Block acquisition mode** (as explained Chapters 1 and 2) is the method that is used for most Real-Time Spectrum Analyzer measurements including real-time spectrum analysis, time domain analysis, and modulation analysis. In this mode, the span **cannot** exceed the maximum real-time bandwidth.
- **Standard SA acquisition mode** is the method that is used to emulate the frequency domain measurements of a traditional swept spectrum analyzer. In this mode, the span **can** exceed the maximum real-time bandwidth.

Standard SA acquisition mode allows the analyzer to make measurements in spans larger than the real-time bandwidth in two specific measurement modes: standard SA mode and SA with spectrogram mode. Note that in these cases the instrument is not

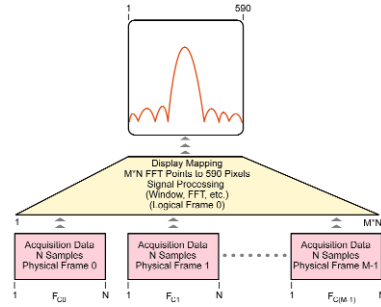

Figure 4-2: Standard SA mode data mapping for spans that exceed the real-time bandwidth. There are N samples per physical frame, M physical frames, and 1 logical frame.

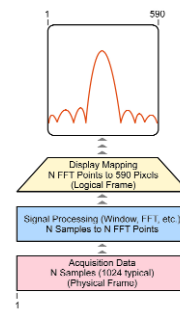

Figure 4-3: Standard SA mode data mapping for spans less than the real-time bandwidth.

making seamless real-time measurements. Instead of acquiring a block of contiguous time domain samples, acquisitions are made on a frame-by-frame basis with gaps in between frames as shown in Figure 4-1. This mode uses two different data structures:

- **Logical Frame:** a set of 590 display points used to represent one span of frequencies. The span of a logical frame may exceed the real-time bandwidth.
- **Physical Frame:** a set of N time-domain samples used to produce one FFT. For spans less than the real-time bandwidth, a single physical frame equates to a single logical frame. For spans greater than the real-time bandwidth, multiple physical frames map into a single logical frame.

For spans exceeding the real-time bandwidth, the span is measured using several physical frames acquired as the RF converter is tuned through the input spectrum in 10 MHz steps. One physical frame is acquired per tuning step. This acquisition sequence is shown in Figure 4-1, and the data mapping is shown in Figures 4-2 and 4-3.

How does the RSA Series front panel differ from a swept SA? Are there any similarities?

The RSA has many of the same controls as its swept predecessors: Center Frequency, Span, Reference Level (Amplitude), RF Attenuation, and other front panel buttons will be very familiar to engineers who have used swept SAs in the past. The RSA also has a standard SA mode where the instrument provides a power vs. frequency display and behaves almost identically to a swept SA.

In standard SA mode, a few RSA parameters look or behave differently from those on swept SAs. Sweep time for a swept spectrum analyzer is equivalent to frame length in an RSA. Frame length depends on span size, number of points acquired, and sample rate. The user can control span size and sometimes the number of points acquired.

In other modes, the RSA has many new controls that support the various real-time measurements that cannot be made with a swept SA. The acquisition timing control allows the user to set how much real-time data to acquire. Acquisitions can be as short as one frame of data or as long as the hardware memory capacity permits. Other new controls pertain to FFT processing. These include number of FFT points, windowing function type selection, and RBW filter types.

The unique triggering controls of the RSA are also new to the field of spectrum analysis. Triggering functions such as frequency mask triggering are simply not possible in a conventional swept SA. The RSA provides precise control over triggering parameters including both frequency and amplitude.

When should I use a RTSA? When should I use a swept SA?

No single analyzer will ever be the best solution for every RF measurement challenge. In fact, many common measurements can be performed with equal effectiveness using either a swept SA or RTSA. In many cases, the RTSA is a more versatile tool, since it provides real-time measurements in addition to basic frequency domain measurements.

- ▶ Measurements of transient and dynamic signals that change over time – RTSA
- ▶ Real-time triggering, seamless capture, and in-depth signal analysis – RTSA
- ▶ Correlation of time, frequency, and modulation domain events — RTSA
- ▶ Modulation analysis for complex communications standards — RTSA or VSA
- ▶ Basic parametric frequency domain measurements — RTSA or swept SA
- ▶ Static signal measurements requiring extremely high dynamic range — swept SA

Glossary

► Primer

Chapter 5: Glossary

Acquisition

An integer number of time-contiguous frames; a block.

Acquisition Time

The length of time represented by one acquisition. Same as block length.

Amplitude

The magnitude of an electrical signal.

Amplitude Modulation (AM)

The process in which the amplitude of a sine wave (the carrier) is varied in accordance with the instantaneous voltage of a second electrical signal (the modulating signal).

Analysis Time

A subset of time-contiguous samples from one block, used as input to an analysis view.

Analysis View

The flexible window used to display real-time measurement results.

Block

An integer number of time-contiguous frames.

Carrier

The RF signal upon which modulation resides.

Carrier Frequency

The frequency of the CW component of the carrier signal.

Center Frequency

The frequency corresponding to the center of a frequency span of the analyzer display.

Codogram

Code channel vs. time vs. power display where the CDMA code channel is represented on x-axis and time respectively on the y-axis. The power level is expressed by the color.

CW Signal

Continuous wave signal – a sine wave.

dBfs

A unit to express power level in decibels referenced to full scale. Depending on the context, this is either the full scale of the display screen or the full scale of the ADC.

dBm

A unit to express power level in decibels referenced to 1 milliwatt.

dBmV

A unit to express voltage levels in decibels referenced to 1 millivolt.

Decibel (dB)

Ten times the logarithm of the ratio of one electrical power to another.

Display Line

A horizontal or vertical line on a waveform display, used as a reference for visual (or automatic) comparison with a given level, time, or frequency.

Distortion

Degradation of a signal, often a result of nonlinear operations, resulting in unwanted frequency components. Harmonic and inter-modulation distortion are common types.

Dynamic Range

The maximum ratio of the levels of two signals simultaneously present at the input which can be measured to a specified accuracy.

FFT

Fast Fourier Transform – a mathematical process to calculate the frequency spectrum of a discrete number of time domain sample points.

Frame

A series of time-contiguous samples; used to calculate a single frequency spectrum.

Frame Length

The amount of time represented by the time domain samples within a frame; a function of the number of sample points and the sampling rate.

Frequency

The rate at which a signal oscillates, expressed as hertz or number of cycles per second.

Frequency Domain View

The representation of the power of the spectral components of a signal as a function of frequency; the spectrum of the signal.

Frequency Drift

Gradual shift or change in displayed frequency over the specified time, where other conditions remain constant. Expressed in hertz per second.

Frequency Mask Trigger

A flexible real-time trigger based on specific events that occur in the frequency domain.

Frequency Modulation (FM)

The process in which the frequency of an electrical signal (the carrier) is varied according to the instantaneous voltage of a second electrical signal (the modulating signal).

Frequency Range

The range of frequencies over which a device operates, with lower and upper bounds.

Frequency Span

A continuous range of frequencies extending between two frequency limits.

Marker

A visually identifiable point on a waveform trace, used to extract a readout of domain and range values represented by that point.

Modulate

To vary a characteristic of a signal, typically in order to transmit information.

Noise

Unwanted random disturbances superimposed on a signal which tend to obscure it.

Noise Floor

The level of noise intrinsic to a system that represents the minimum limit at which input signals can be observed; ultimately limited by thermal noise (kTB).

Noise Bandwidth (NBW)

The exact bandwidth of a filter that is used to calculate the absolute power in dBm/Hz.

Real-Time Bandwidth

The frequency span over which real-time seamless capture can be performed, which is a function of the digitizer and the IF bandwidth of a Real-Time Spectrum Analyzer.

Real-Time Seamless Capture

The ability to acquire and store an uninterrupted series of time domain samples that represent the behavior of an RF signal over a long period of time.

Real-Time Spectrum Analysis

Measurement technique based triggering on an RF signal, seamlessly capturing it into memory, and analyzing it in the frequency, time, and modulation domains.

Reference Level

The signal level represented by the uppermost graticule line of the analyzer display.

Resolution Bandwidth (RBW)

The width of the narrowest filter in the IF stages of a spectrum analyzer. The RBW determines the analyzer's ability to resolve closely spaced signal components.

Sensitivity

Measure of a spectrum analyzer's ability to display minimum level signals, usually expressed as displayed average noise level (DANL).

Spectrogram

Frequency vs. time vs. amplitude display where the frequency is represented on x-axis and time on the y-axis. The power is expressed by the color.

Spectrum

The frequency domain representation of a signal showing the power distribution of its spectral component versus frequency.

Spectrum Analysis

Measurement technique for determining the frequency content of an RF signal.

Vector Signal Analysis

Measurement technique for characterizing the modulation of an RF signal.

Acronym Reference

► Primer

Acronym Reference

ADC:	Analog-to-Digital Converter
AM:	Amplitude Modulation
BH4B:	Blackman-Harris 4B Window
CCDF:	Complementary Cumulative Distribution Function
CDMA:	Code Division Multiple Access
CW:	Continuous Wave
dB:	Decibel
dBfs:	dB Full Scale
DDC:	Digital Down Converter
DSP:	Digital Signal Processing
EVM:	Error Vector Magnitude
FFT:	Fast Fourier Transform
FM:	Frequency Modulation
FSK:	Frequency Shift Keying
IF:	Intermediate Frequency
I/Q:	In-Phase / Quadrature
LO:	Local Oscillator
NBW:	Noise Bandwidth
OFDM:	Orthogonal Frequency Division Multiplexing
PM:	Phase Modulation
PSK:	Phase Shift Keying
QAM:	Quadrature Amplitude Modulation
RBW:	Resolution Bandwidth
RF:	Radio Frequency
rms:	Root Mean Square
RSA:	Tektronix' Real-Time Spectrum Analyzer
RTSA:	Real-Time Spectrum Analyzer
SA:	Spectrum Analyzer
VSA:	Vector Signal Analyzer

Contact Tektronix:

ASEAN / Australasia / Pakistan (65) 6356 3900
Austria +43 2236 8092 262
Belgium +32 (2) 715 89 70
Brazil & South America 55 (11) 3741-8360
Canada 1 (800) 661-5625
Central Europe & Greece +43 2236 8092 301
Denmark +45 44 850 700
Finland +358 (9) 4783 400
France & North Africa +33 (0) 1 69 86 80 34
Germany +49 (221) 94 77 400
Hong Kong (852) 2585-6688
India (91) 80-22275577
Italy +39 (02) 25086 1
Japan 81 (3) 6714-3010
Mexico, Central America & Caribbean 52 (55) 56666-333
The Netherlands +31 (0) 23 569 5555
Norway +47 22 07 07 00
People's Republic of China 86 (10) 6235 1230
Poland +48 (0) 22 521 53 40
Republic of Korea 82 (2) 528-5299
Russia, CIS & The Baltics +358 (9) 4783 400
South Africa +27 11 254 8360
Spain (+34) 901 988 054
Sweden +46 8 477 6503/4
Taiwan 886 (2) 2722-9622
United Kingdom & Eire +44 (0) 1344 392400
USA 1 (800) 426-2200
USA (Export Sales) 1 (503) 627-1916
For other areas contact Tektronix, Inc. at: 1 (503) 627-7111

For Further Information

Tektronix maintains a comprehensive, constantly expanding collection of application notes, technical briefs and other resources to help engineers working on the cutting edge of technology. Please visit www.tektronix.com



Copyright © 2004, Tektronix, Inc. All rights reserved. Tektronix products are covered by U.S. and foreign patents, issued and pending. Information in this publication supersedes that in all previously published material. Specification and price change privileges reserved. TEKTRONIX and TEK are registered trademarks of Tektronix, Inc. All other trade names referenced are the service marks, trademarks or registered trademarks of their respective companies.

09/04 HA/WOW

37W-17249-0

www.tektronix.com/rsa

Tektronix
Enabling Innovation

